

Serien- und Projektleuchten  
*Series and project luminaires*

berliner ring

bullauge

one piece

oval office

projektleuchten



Made in Brandenburg

Überblick 4  
*Overview*

Serienleuchten  
*Series luminaires*

berliner ring 22

bullauge 54

one piece 70

oval office 86

Projektleuchten  
*Project luminaires*

Tisch- und Stehleuchten 98  
*Table and floor lamps*

Pendelleuchten 120  
*Pendant lights*

Außenleuchten 128  
*Outdoor lights*

Individuell gefertigte Leuchten 134  
*Customized luminaires*

Technische Informationen zu den Leuchten finden Sie auf der Website von mawa.  
Technical information about our luminaires can be found on the mawa website.



## Unsichtbar und doch individuell Invisible and yet individual

Serienleuchten von mawa verkörpern Licht in Funktion. Frei von Moden und schnörkellos im Design verschreiben sie sich ihrer Beleuchtungsaufgabe und drängen sich optisch nicht in den Vordergrund. Das lässt die Herzen vieler Fachleute höherschlagen, die sich der Bedeutung guter Beleuchtung bewusst sind.

Dabei rückt gezielte Individualisierung zunehmend in den Vordergrund. Die mawa Produktion vor Ort lässt diese Wünsche auf kurzem Weg wahr werden – ob zusätzliches Downlight im Deckenfluter, Integration von Notlichtkomponenten oder maßgeschneiderte Taster-Lösungen. Mit großer Fertigungstiefe und topausgebildeten Mitarbeitenden ist mawa ein zuverlässiger Partner für Ihre Visionen.

Series luminaires from mawa embody light in function. Free of trends and straightforward in design, they are dedicated to your lighting task and do not push themselves visually into the foreground. That makes the hearts of many interior designers beat faster.

Now that people are aware of the importance of good lighting, targeted customization is increasingly coming to the fore. The mawa production on site makes these wishes come true within a short period of time, whether it is an additional downlight in ceiling washlights, integration of emergency lighting components or customized push button solutions. With a wide vertical range of manufacture and excellently trained employees, mawa is a reliable partner for your visions.

# Überblick Overview

## Serienleuchten Series luminaires

### berliner ring



berliner ring 1  
downlight  
> 26



berliner ring 1  
inlight  
> 32



berliner ring 1  
up-/downlight  
> 38



berliner ring 2  
> 46



berliner ring 3  
> 50

### bullauge

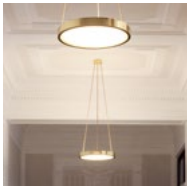

bullauge 5  
> 56

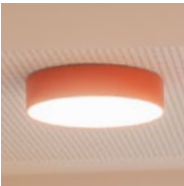

bullauge 6 450 mm  
> 62



bullauge 6 600 mm  
> 63



bullauge 6 800 mm  
> 66



bullauge 6 1200 mm  
> 67

### one piece



one piece 6  
> 72



one piece 7  
> 72



one piece 8  
> 76



one piece 9  
> 76

### oval office

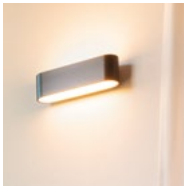

oval office 3  
oval office 4  
> 90



oval office 7  
oval office 8  
> 92

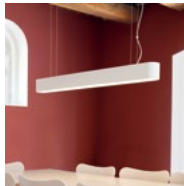

oval office 5  
oval office 6  
> 94

## Projektleuchten Project luminaires

### Tisch- und Stehleuchten Table and floor lamps



elle 1  
> 100

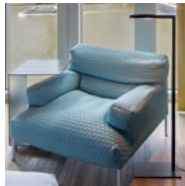

elle 2  
> 104



elle 4  
> 108

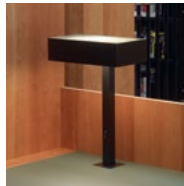

grimm  
> 110

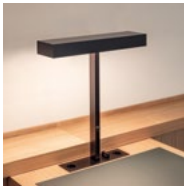

potsdam  
> 112



langer kerl  
> 116

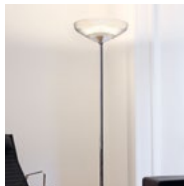

basel  
> 118

# Überblick

## Overview

### Pendelleuchten Pendant lights

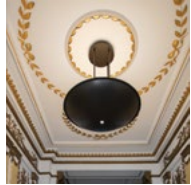

charlottenburg  
> 122



humboldt uni 1  
> 126

### Außenleuchten Outdoor lights

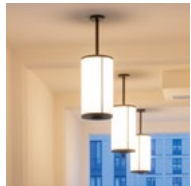

spittelmarkt  
> 130

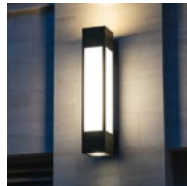

unter den linden 1  
unter den linden 2  
> 132

### Individuell gefertigte Leuchten Customized luminaires



> 134

»Unserem Kerngeschäft, den technischen Leuchten-systemen, die mawa produziert, sieht man eine Beeinflussung der klassischen Moderne an. Dabei verfolgen wir bei Neuentwicklungen immer ein wichtiges Ziel: Nachhaltigkeit, auch im Design. Das heißt, unsere Produkte müssen durabel sein, gerne auch moderesistent, nach Jahren des Gebrauchs technisch und optisch funktionieren – übertrieben ausgedrückt: auch in Würde altern. Das ist, denke ich, unser größter Beitrag zur Nachhaltigkeit.«

Martin Wallroth, Gründer

*“You can see an influence of the classical modernism age on our core business, the technical lighting systems that mawa produces. Thereby we always pursue an important goal with new developments: sustainability, also in design. That means our products must be durable, preferably also resistant to trends, functioning technically and optically after years of use – in exaggerated terms: age with dignity. I think this is our greatest contribution to sustainability.”*

Martin Wallroth, founder

created and manufactured  
in Brandenburg



# von Idee bis Herstellung

*from the idea to the production*

mawa ist eine Hightech-Manufaktur für anspruchsvolle, komplexe und innovative Lichttechnik südwestlich von Berlin. Als Entwickler, Produzenten und Dienstleister sind wir für unsere Auftraggebenden stets auf der Suche nach technisch exzellenten Lösungen für ihre individuellen Lichtprojekte. Eine hohe Fertigungstiefe ist unser Kapital: Selbst kleine Stückzahlen oder Einzelstücke können in kurzer Zeit produziert werden.

mawa is a high-tech manufacture for sophisticated, complex and innovative lighting technology southwest of Berlin. As developers, producers and service providers, we are always on the lookout for technically excellent solutions for our costumers' individual lighting projects. A high vertical range of manufacture is our capital: Even small quantities or individual pieces can be produced in a short time.

unter einem Dach  
*under one roof*

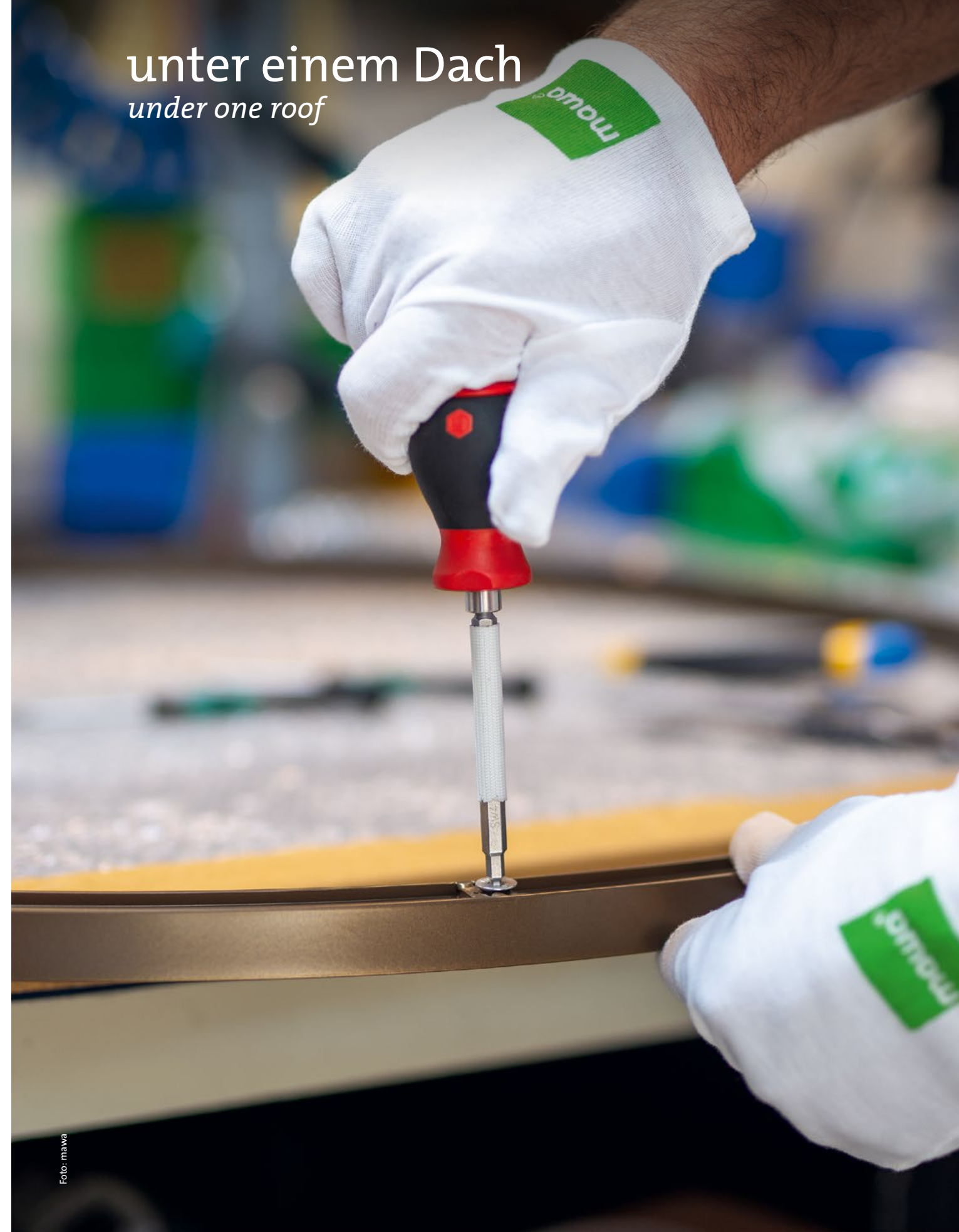

Handwerk und Robotik vereint  
*craft and robotics united*

mit Oberflächen in allen Farben  
*with surfaces in all colors*

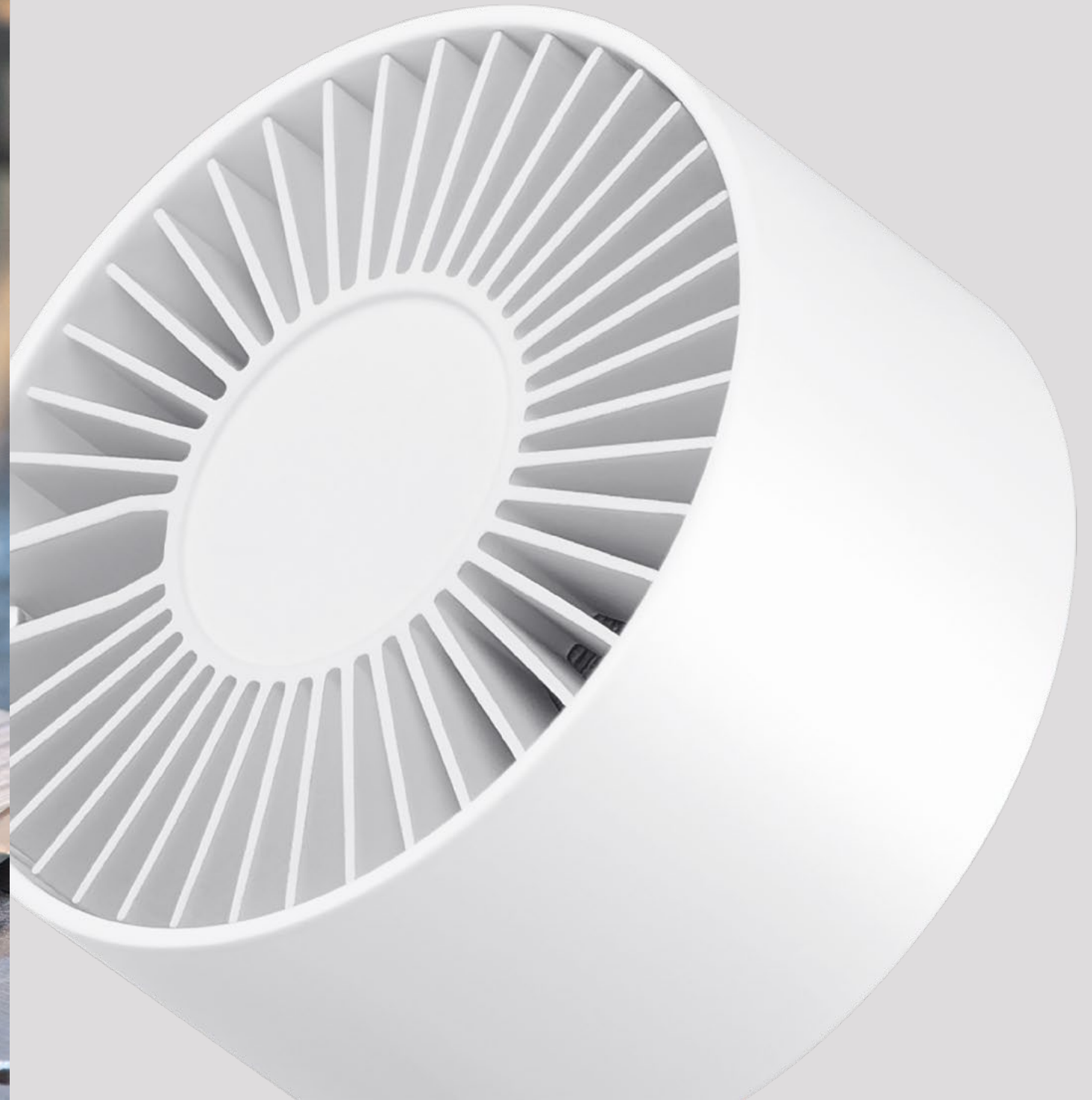



Neueste CNC-Technologien und verschiedene Fachleute unter einem Dach ermöglichen die Herstellung von originalgetreuen Reproduktionen für Baudenkmäler und schaffen Lichtbedingungen in Ausstellungen, die den konservatorischen Anforderungen mehr als gerecht werden.

Standort Seddiner See, Aufnahmen von der Herstellung originalgetreuer Leuchten für die Neue Nationalgalerie von Mies van der Rohe in Berlin  
Location Seddiner See, shots of the production of original luminaires for the Neue Nationalgalerie by Mies van der Rohe in Berlin



Latest CNC technologies and various experts under one roof enable the production of authentic reproductions for architectural monuments and create lighting conditions in exhibitions that fully meet conservational requirements.

Individuell angefertigte Leuchten sind kein Problem für uns. mawa entwickelt, konstruiert, produziert und montiert in der eigenen, DEKRA-zertifizierten Fertigungsstätte bei Potsdam.  
Customized luminaires are no problem for us. mawa develops, designs, produces and assembles in its own DEKRA-certified manufacturing facility near Potsdam.



Fotos: mawa, Leon Koppfow, WFB

An die Gestaltung der Oberflächen stellen wir höchste Ansprüche. Zugleich sind wir für große Experimentierfreude bekannt. Unsere Leuchten sind erstklassig pulverbeschichtet – so hervorragend, dass Fachleute sie schon mal für nasslackiert hielten. Die hochwertige Fertigung und Materialität erlauben es sogar, komplett auf Beschichtung zu verzichten.



We place the highest demands on the design of surfaces. At the same time, we are known for our great love of experimentation. Our luminaires are powder-coated to a first-class standard: so excellently that experts sometimes thought they were wet-painted. The high-quality manufacturing and materiality even allows us to dispense with coating completely.



Fotos: Leon Kopplov, mawa

# Material, Oberflächen, Farben

## Material, surfaces, colors

Leuchten von mawa sind etwas Besonderes. Die äußerst feine und besonders glatte Pulverbeschichtung, standardmäßig in Schwarz oder Weiß, überzeugt Fingerspitzen und Augen gleichermaßen. Allerdings stellt sie hohe Ansprüche an die Beschaffenheit des Rohmaterials, die mawa mit präziser CNC-Technik und topausgebildeten Metallverarbeitenden gewissenhaft erfüllt.

Dieses Beschichtungsverfahren und die langjährige Zusammenarbeit mit zuverlässigen Partner:innen ermöglichen die Umsetzung normierter Farbsysteme und speziell entwickelter Effekt-Pulver.

Auf diese Weise lassen sich Bronze nachbilden und eloxierte Oberflächen überzeugend imitieren. Oberflächen in »mawa Eloxa« sind im Vergleich zum Original weniger empfindlich, homogen in Farbe und wiederholgenau im Erscheinungsbild.

Dem Zeitgeist zu entsprechen und sich doch frei von Moden zu bewegen, bedeutet für mawa farbige Oberflächen anzubieten, die Leuchten in trendresistente Statements verwandeln.

Mit Hochglanz überzeugen Einzelkomponenten und dekorative Glasschirme in Chrom, Messing oder Kupfer-Optik. Ob galvanisch veredelt oder professionell bedampft, sie verleihen zeitloser Formensprache das gewisse Etwas.

Auf besonderen Wunsch wird gänzlich auf Beschichtung verzichtet, sodass Bearbeitungsspuren oder gezieltes Schliffbild die technische Anmutung dominieren.

Luminaires from mawa are something special. The extremely fine and particularly smooth powder coating, as standard in black or white, impresses fingertips and eyes alike. However, it makes high demands on the quality of the raw material, which mawa conscientiously meets with precise CNC technology and highly trained metalworkers.

This coating process and the long-term cooperation with reliable partners enable the implementation of standardized color systems and specially developed effect powders.

In this way, bronze can be reproduced and anodized surfaces can be convincingly imitated. Surfaces in "mawa Eloxa" are less sensitive compared to the original, homogeneous in color and repeatable in appearance.



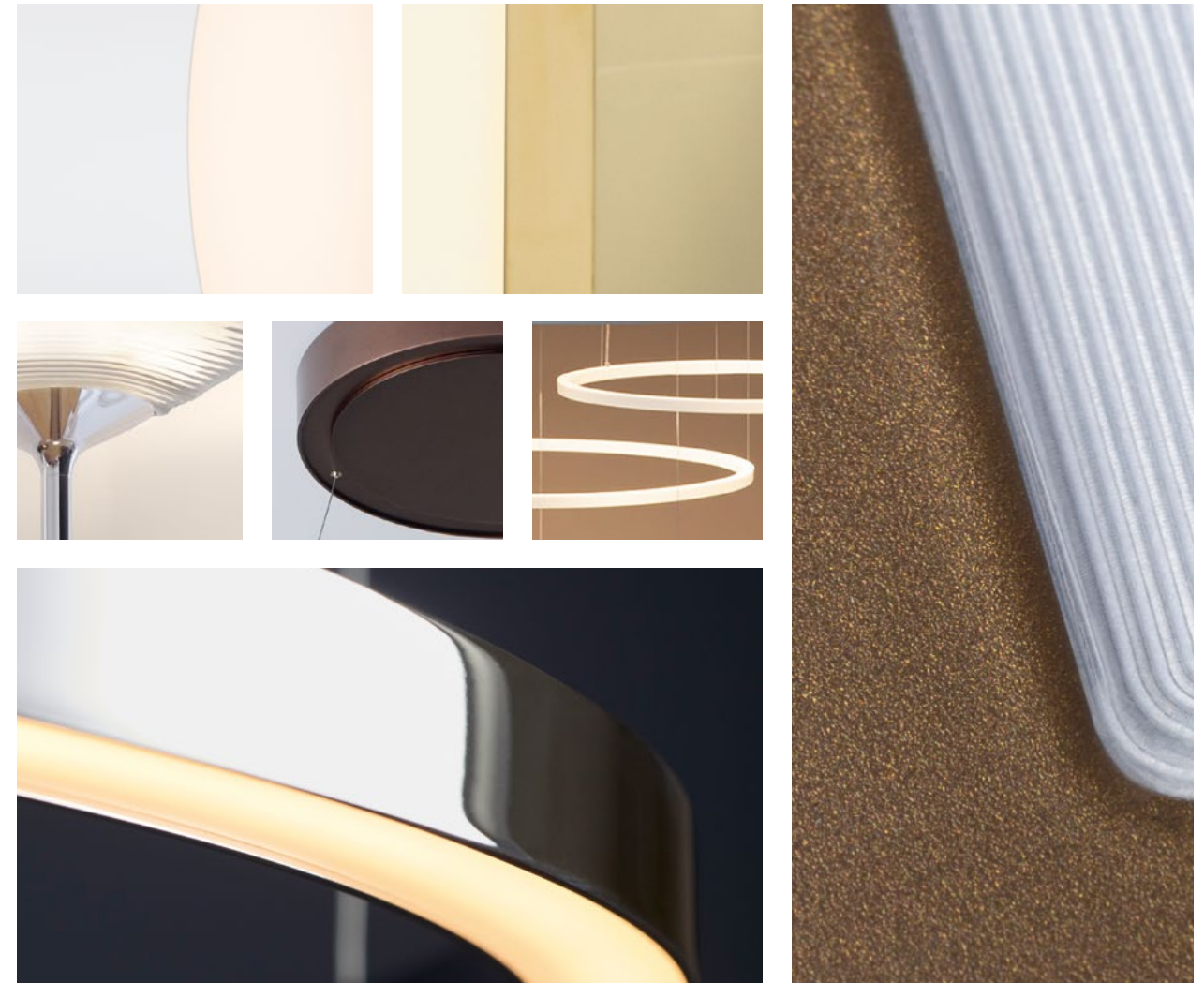

For mawa, being zeitgeisty and still moving free of fashions means offering colored surfaces that transform luminaires into trend-resistant statements.

Individual components and decorative glass shades in chrome, brass or copper look impress with high gloss. Regardless of whether they are electroplated or professionally steamed, they stand for timeless design language and a certain je ne sais quoi.







On special request, no coating is used at all, so that traces of processing or specific grinding patterns dominate the technical appearance.









### Materialien Materials

-  Aluminium aluminum
-  Edelstahl stainless steel
-  Bronze bronze
-  Messing brass

### Pulverbeschichtungen Powder coatings

-  weiß matt (RAL 9016) white matt (RAL 9016)
-  schwarz matt (RAL 9005) black matt (RAL 9005)
-  grau metallic (DB 702) grey metallic (DB 702)
-  bronze bronze
-  dunkelbronze dark bronze
-  messing brüniert brass burnished

### Oberflächenveredelungen Surface finishings

-  chrom chrome
-  messing brass
-  kupfer copper
-  silber eloxiert silver anodized
-  blattvergoldet gold leaf
-  blattversilbert silver leaf

Oder doch eine andere Farbe? Die Farbvielfalt ist unbegrenzt. Auf Wunsch sind bei mawa alle RAL-Farben, Pantone® und NCS möglich.

Or a different color after all? The variety of colors is unlimited. Upon request, all RAL colors, Pantone® and NCS are possible at mawa.

# mawa ist Pionier mawa is a pioneer

mawas Designverständnis und Innovationsanspruch zeigen sich in der exzellenten Verarbeitung der Produkte, in technischer Raffinesse und in den eigenen Patenten. Alle Produkte sind Originale, die von der ersten Skizze bis zum serienreifen Prototypen südwestlich von Berlin am Seddiner Standort entwickelt und gefertigt werden. In der Fachwelt sind sie anerkannt – sie befinden sich in den Sammlungen von Museen auf der ganzen Welt, sie gewinnen Designpreise und sind Gegenstand verschiedenster Publikationen.

mawa's understanding of design and claim to innovation are reflected in the excellent workmanship of its products, in technical sophistication and in the patents held. All products are originals, which are developed and manufactured at the Seddin site south of Berlin from the first sketch to the production-ready prototype. They are recognized in the professional world — they are in the collections of museums all over the world, they win design awards and are the subject of various publications.

**DESIGN PLUS**  
powered by: **light+building**  
2020



Focus Open 2019  
Special Mention



reddot award 2019  
winner



reddot award 2018  
winner



Auszeichnungen Ständige Sammlung MoMA New York ·  
Museum of Contemporary Art Chicago · Die gute  
Industrieform der Hannover-Messe · Kunstgewerbe-  
museum Hamburg · Haus der Industrieform Essen ·  
Biennale Kortrijk Belgien · design center stuttgart ·  
Museum für Angewandte Kunst Köln · Vitra-Design-  
Sammlung, Weil am Rhein · Sammlung Kunstgewerbe-  
museum Berlin · Designcenter Stuttgart · Sammlung  
Museum für Kunsthandwerk, Frankfurt/Main ·  
Designsammlung Pforzheim · Deutscher Designers'  
Saturday Düsseldorf · Neue Sammlung Nürnberg ·  
Sammlung Grassi Museum Leipzig · Sammlung Stiftung  
Staatliches Museum für Angewandte Kunst, Nürnberg ·  
Form | Messe Frankfurt am Main · Nominierungsliste  
Großer Preis des Mittelstandes · IF Design Award ·  
Sonderausstellung Corbusierhaus Berlin Designcontest  
Osram · Design Plus IF · Nominierung Designpreis der  
Bundesrepublik Deutschland · interior innovation award  
Best of Best · interior innovation award winner ·  
Nominierung German Design Award · German Design  
Award 2017 / 2018 · Designpreis Brandenburg 2017 /  
2021 · Financial Times "FT 1000 Europe's fastest growing  
companies" · Focus Spezial Wachstumschampion ·  
Design Plus Light & Building 2018 / 2020 · GOOD DESIGN  
Award The Chicago Athenaeum 2018 / 2020 / 2021 ·  
Lighting Design Awards 2017 / 2018 · Stylepark Selected ·  
Red Dot Award Product Design Winner 2018 / 2019 ·  
Focus Open Internationaler Designpreis Baden-  
Württemberg 2019 / 2020 / 2021 uvm.

# berliner ring

Die Pendelleuchten berliner ring überzeugen mit filigranem Profil und besonders homogenem Lichtaustritt in zwei verschiedenen Leistungsstufen. Die Produktion im eigenen Hause von mawa ermöglicht eine individuelle Gestaltung.

*The berliner ring pendant lights impress with their filigree profile and particularly homogeneous light emission in two different power levels. The in-house production of mawa enables individual design according to customer requirements.*



Fotos: matwa

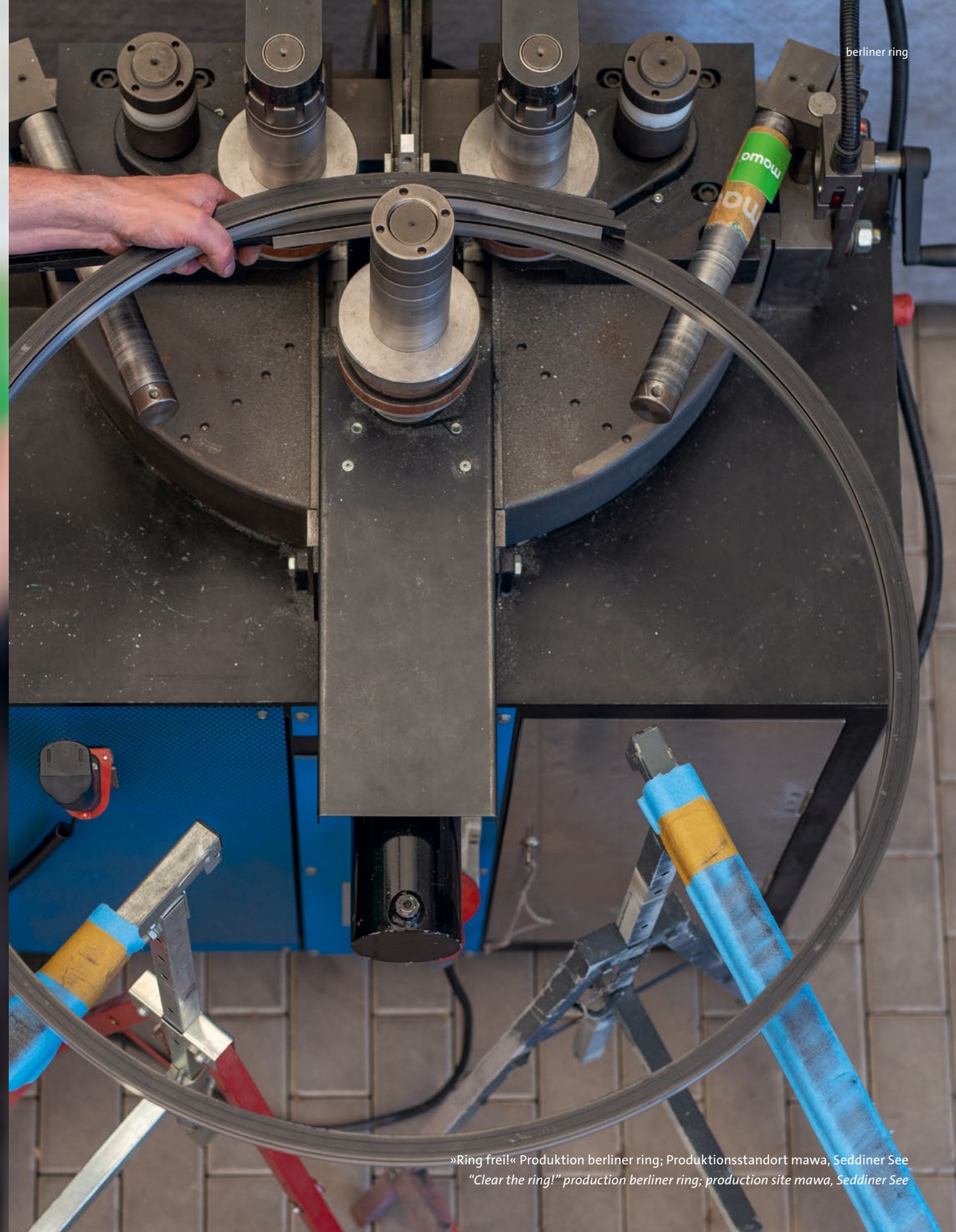

berliner ring

»Ring frei!« Produktion berliner ring; Produktionsstandort mawa, Seddiner See  
"Clear the ring!" production berliner ring; production site mawa, Seddiner See

berliner ring 1 downlight im schlanken U-Profil  
berliner ring 1 downlight in slim U-profile

Design: Martin Wallroth

**br1-dl**

LED-Band:

24 V DC, 22 W pro Meter (2700 K: 124 lm/W, 3000 K: 127 lm/W), Ra > 90

Ø 600 mm: 42 W, 2700 K/5210 lm, 40 W, 3000 K/5080 lm

Ø 800 mm: 55 W, 2700 K/6820 lm, 53 W, 3000 K/6730 lm

Ø 1000 mm: 66,5 W, 2700 K/7713 lm, 63 W, 3000 K/7477 lm

Ø 1200 mm: 81 W, 2700 K/9357 lm, 76,2 W, 3000 K/9070 lm

Profil 20 x 20 mm (B x H)

LED strip:

24 V DC, 22 W per meter (2700 K: 124 lm/W, 3000 K: 127 lm/W), Ra > 90

Ø 600 mm: 42 W, 2700 K/5210 lm, 40 W, 3000 K/5080 lm

Ø 800 mm: 55 W, 2700 K/6820 lm, 53 W, 3000 K/6730 lm

Ø 1000 mm: 66,5 W, 2700 K/7713 lm, 63 W, 3000 K/7477 lm

Ø 1200 mm: 81 W, 2700 K/9357 lm, 76,2 W, 3000 K/9070 lm

Profile 20 x 20 mm (W x H)

Gehäuse Housing



Weitere technische Infos auf Seite 43  
More technical info on page 43



br1-dl-r-600

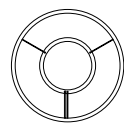
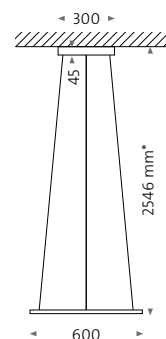

br1-dl-r-800

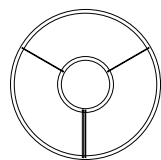
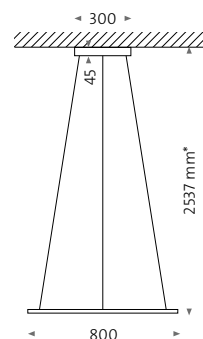

br1-dl-r-1000

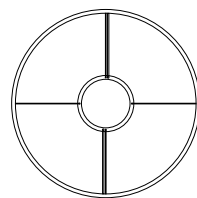
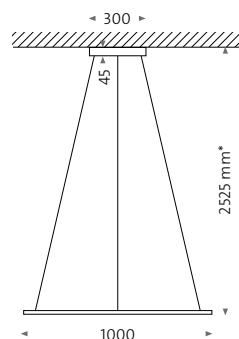

br1-dl-r-1200

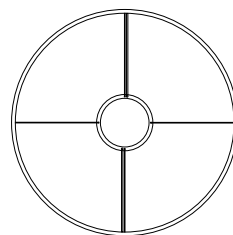
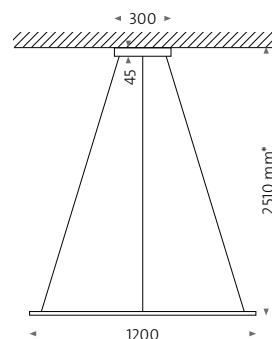

Individuell gefertigter berliner ring 1 downlight im schlanken U-Profil  
Customized berliner ring 1 downlight in slim U-profile

Maßstab 1:15 Scale 1:15

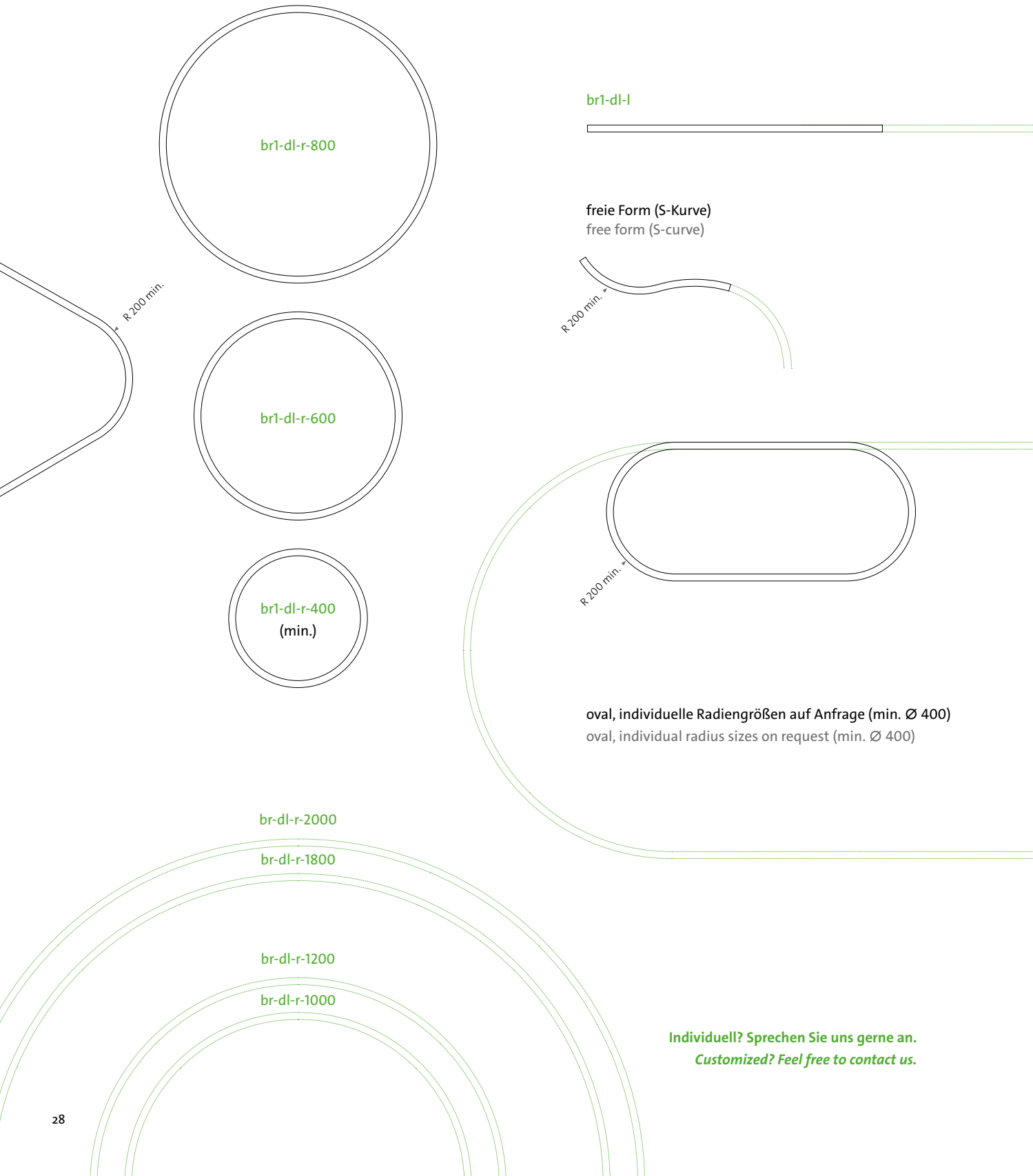

Individuell? Sprechen Sie uns gerne an.  
Customized? Feel free to contact us.







berliner ring 1 inlight im schlanken C-Profil  
berliner ring 1 inlight in slim C-profile

Design: Martin Wallroth

**br1-il**

LED-Band:

24 V DC, 22 W pro Meter (2700 K: 124 lm/W, 3000 K: 127 lm/W), Ra > 90

Ø 600 mm: 42 W, 2700 K / 5210 lm, 40 W, 3000 K / 5080 lm

Ø 800 mm: 55 W, 2700 K / 6820 lm, 53 W, 3000 K / 6730 lm

Ø 1000 mm: 68,5 W, 2700 K / 7944 lm, 65 W, 3000 K / 7700 lm

Ø 1200 mm: 82,2 W, 2700 K / 9533 lm, 77,7 W, 3000 K / 9242 lm

Profil 20 x 20 mm (B x H)

LED strip:

24 V DC, 22 W per meter (2700 K: 124 lm/W, 3000 K: 127 lm/W), Ra > 90

Ø 600 mm: 42 W, 2700 K / 5210 lm, 40 W, 3000 K / 5080 lm

Ø 800 mm: 55 W, 2700 K / 6820 lm, 53 W, 3000 K / 6730 lm

Ø 1000 mm: 68,5 W, 2700 K / 7944 lm, 65 W, 3000 K / 7700 lm

Ø 1200 mm: 82,2 W, 2700 K / 9533 lm, 77,7 W, 3000 K / 9242 lm

Profile 20 x 20 mm (W x H)

Gehäuse Housing



Weitere technische Infos auf Seite 43  
More technical info on page 43



br1-il-r-600

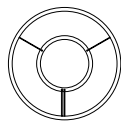
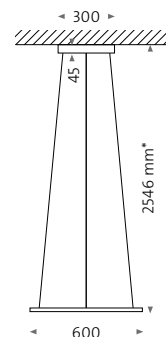

br1-il-r-800

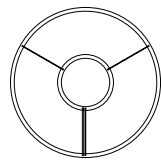
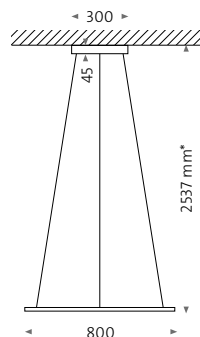

br1-il-r-1000

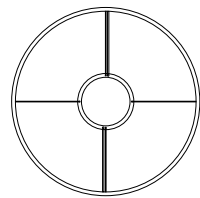
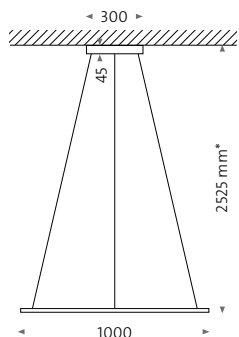

br1-il-r-1200

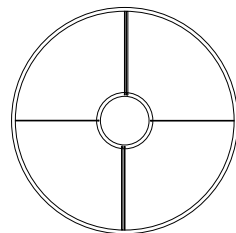
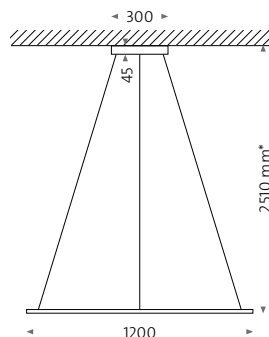

berliner ring

Individuell gefertigter berliner ring 1 inlight im schlanken U-Profil  
Customized berliner ring 1 inlight in slim U-profile

Maßstab 1:15 Scale 1:15

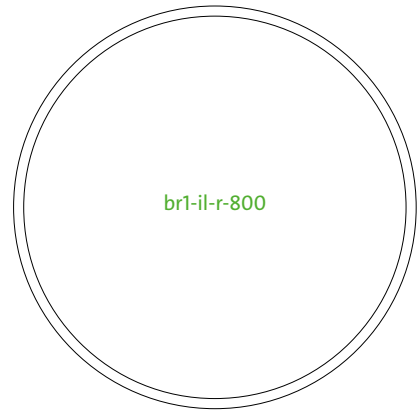

br1-il-r-800



br1-il-r-600  
(min. Ø 600)

br1-il-l

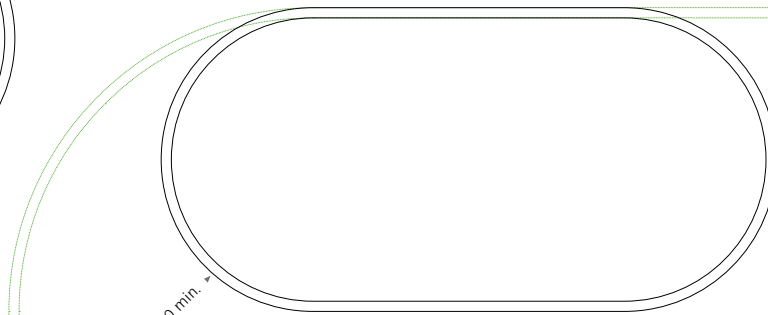
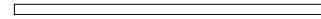

R-300 min.

oval  
individuelle Radiengrößen auf Anfrage (min. Ø 600)  
oval  
individual radius sizes on request (min. Ø 600)

br1-il-r-1200

br1-il-r-1000

Individuell? Sprechen Sie uns gerne an.  
Customized? Feel free to contact us.



Foto: Stefan Wolf Lucke

berliner ring 1 downlight br1-dl gruppiert; Waldkliniken Eisenberg  
berliner ring 1 downlight br1-dl grouped; Waldkliniken Eisenberg

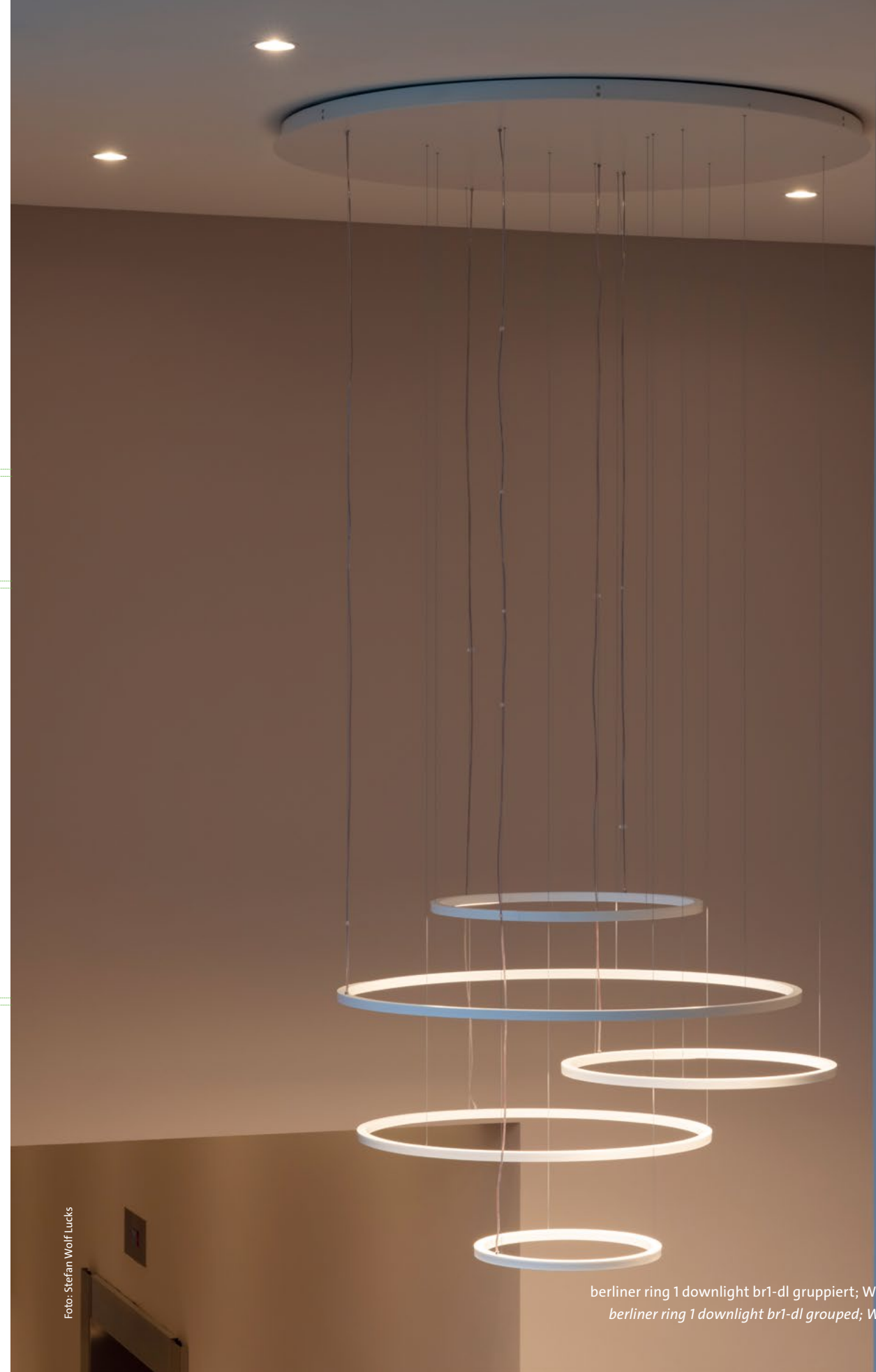

berliner ring

Foto: Stefan Wolf Lucks

berliner ring 1 up- und downlight br1-ud; Waldkliniken Eisenberg  
berliner ring 1 up- and downlight br1-ud; Waldkliniken Eisenberg

berliner ring 1 up- und downlight in zwei schlanken U-Profilen  
berliner ring 1 up- and downlight in two slim U-profiles

Design: Martin Wallroth

**br1-ud**

LED-Band:

24 V DC, 22 W pro Meter (2700 K: 124 lm/W, 3000 K: 127 lm/W), Ra > 90

Up- und Downlight jeweils:

Ø 600 mm: 42 W, 2700 K / 5210 lm, 40 W, 3000 K / 5080 lm

Ø 800 mm: 55 W, 2700 K / 6820 lm, 53 W, 3000 K / 6730 lm

Ø 1000 mm: 66,5 W, 2700 K / 7713 lm, 63 W, 3000 K / 7477 lm

Ø 1200 mm: 81 W, 2700 K / 9357 lm, 76,2 W, 3000 K / 9070 lm

Profil 20 x 43 mm (B x H)

LED strip:

24 V DC, 22 W per Meter (2700 K: 124 lm/W, 3000 K: 127 lm/W), Ra > 90

Up- and Downlight each:

Ø 600 mm: 42 W, 2700 K / 5210 lm, 40 W 3000 K / 5080 lm

Ø 800 mm: 55 W, 2700 K / 6820 lm, 53 W 3000 K / 6730 lm

Ø 1000 mm: 66,5 W, 2700 K / 7713 lm, 63 W, 3000 K / 7477 lm

Ø 1200 mm: 81 W, 2700 K / 9357 lm, 76,2 W, 3000 K / 9070 lm

Profile 20 x 43 mm (W x H)

Gehäuse Housing



Weitere technische Infos auf Seite 43  
More technical info on page 43



br1-ud-r-600

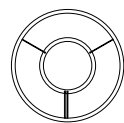
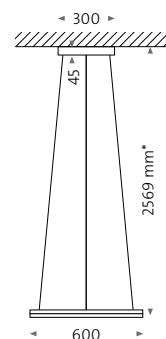

br1-ud-r-800

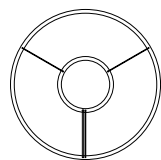
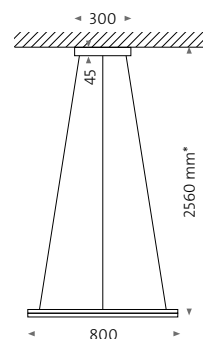

br1-ud-r-1000

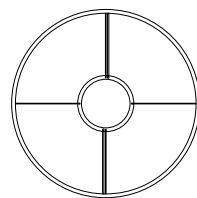
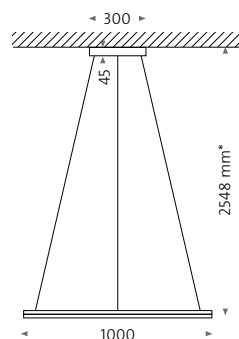

br1-ud-r-1200

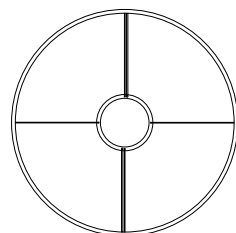
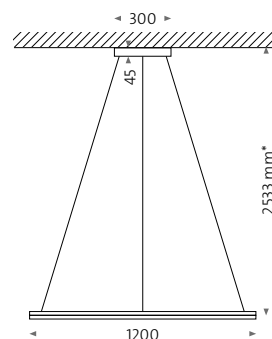

Individuell gefertigter berliner ring 1 up- und downlight im schlanken U-Profil  
Customized berliner ring 1 up- and downlight in slim U-profile

Maßstab 1:15 Scale 1:15

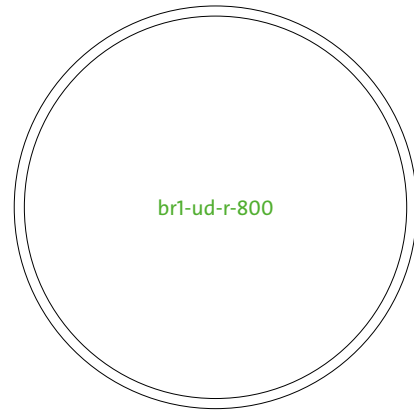

br1-ud-r-800

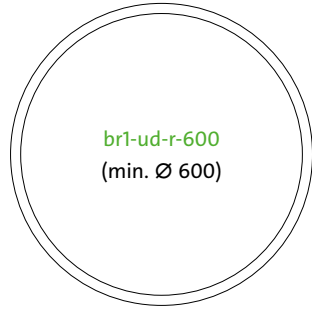

br1-ud-r-600  
(min. Ø 600)

br1-ul-l

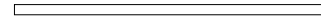

freie Form (S-Kurve)  
free form (S-curve)

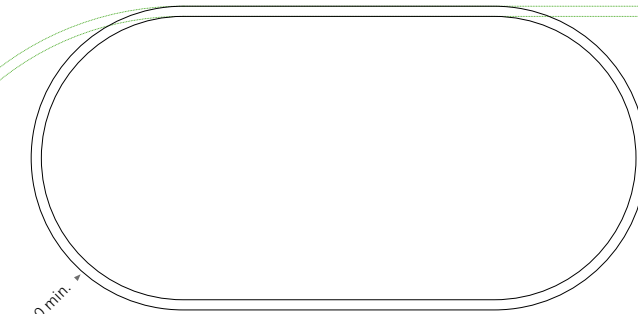
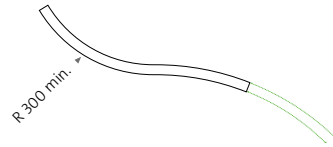

oval, individuelle Radiengrößen auf Anfrage  
oval, individual radius sizes on request

br-ud-r-2000

br-ud-r-1800

br-ud-r-1200

br-ud-r-1000

Individuell? Sprechen Sie uns gerne an.  
Customized? Feel free to contact us.

berliner ring



Carl Friedrich Gauss  
is considered to be the  
German mathematician of the  
century. His story becomes  
the more impressive consider  
he came from a poor family and  
had limited resources at the  
Fortunately, a Duke noticed  
potential and sent him to school  
His discoveries and writings  
influenced and left a lasting  
in the areas of number theory,  
astronomy, geodesy, and physics  
particularly the study of electro  
magnetism.

Foto: Stefan Wolf Lucks

berliner ring 1 up- und downlight br1-ud Ø 2500 mm; AI Campus | Merantix, Berlin  
berliner ring 1 up- and downlight br1-ud Ø 2500 mm; AI Campus | Merantix, Berlin

**br1-ba-r-g**

Zentrale Abhängung mit integriertem Betriebsgerät  
Ø 300 mm  
Central suspension with integrated control gear  
Ø 300 mm

Baldachin gross (Standard) Canopy large (standard)

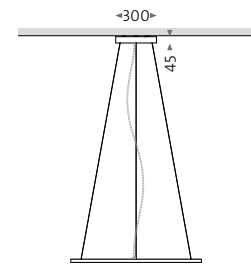

br1-dl-r-800  
(exemplarische Größe  
exemplary size)



**br1-ba-r-k**

Senkrechte Abpendelungen für Kabelanschluss  
(inklusive Betriebsgerät, muss extern platziert werden)  
Vertical suspension for cable connection  
(control gear included, must be placed externally)

Baldachin klein Canopy small

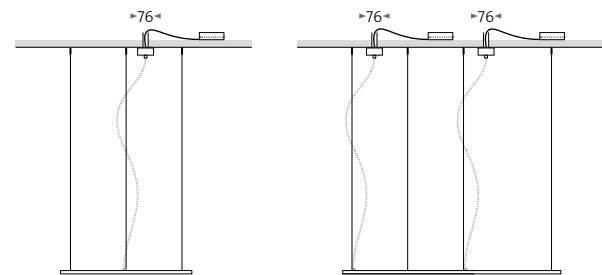

br1-dl-r-600  
br1-dl-r-800  
(exemplarische Größe  
exemplary size)

br1-dl-r-1000  
br1-dl-r-1200  
(exemplarische Größe  
exemplary size)

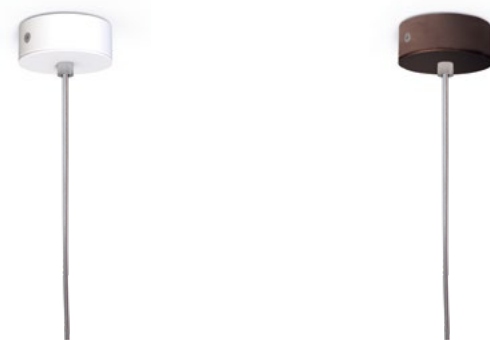

# berliner ring 1 – Technische Informationen

## berliner ring 1 – Technical information

■ = verfügbar available  
■ = auf Anfrage on request  
□ = nicht verfügbar not available

|   |   | br1-dl         |      | br1-il        |      | br1-ud                        |      |        |      |
|---|---|----------------|------|---------------|------|-------------------------------|------|--------|------|
| Lichtaustritt Light direction               |   | Downlight (dl) |      | Inlight (il)  |      | Uplight (ul) + Downlight (dl) |      |        |      |
| Lichtfarbe Light color                      |   | 2700 K 3000 K  |      | 2700 K 3000 K |      | 2700 K 3000 K                 |      | 3000 K |      |
|   |   |                |      |               |      | dl                            | ul   | dl     | ul   |
| Lichtstrom/Wattage<br>Luminous flux/Wattage | Ø 600 mm  | lm 5210        | 5080 | 5210          | 5080 | 5210                          | 5210 | 5080   | 5080 |
|   |   | W 42           | 40   | 42            | 40   | 42                            | 42   | 40     | 40   |
|   | Ø 800 mm  | lm 6820        | 6730 | 6820          | 6730 | 6820                          | 6820 | 6730   | 6730 |
|   |   | W 55           | 53   | 55            | 53   | 55                            | 55   | 53     | 53   |
|   | Ø 1000 mm   | lm 7713        | 7477 | 7944          | 7700 | 7713                          | 7713 | 7477   | 7477 |
|   |   | W 66,5         | 63   | 68,5          | 65   | 66,5                          | 66,5 | 63     | 63   |
|   | Ø 1200 mm   | lm 9357        | 9070 | 9533          | 9242 | 9357                          | 9357 | 9070   | 9070 |
|   |   | W 81           | 76,2 | 82,2          | 77,7 | 81                            | 81   | 76,2   | 76,2 |
| Steuerung Controller                        | DALI -4   | ■              | ■    | ■             | ■    | ■                             | ■    | ■      | ■    |
|   | Phasenanschnitt/-abschnitt<br>Leading edge/trailing edge -7 | ■              | ■    | ■             | ■    | ■                             | ■    | ■      | ■    |
|   | Bluetooth -9  | ■              | ■    | ■             | ■    | ■                             | ■    | ■      | ■    |
| Gewicht Weight                              | Ø 600 mm  | 2.840 g        |      | 2.840 g       |      | 3.680 g                       |      |        |      |
|   | Ø 800 mm  | 3.100 g        |      | 3.100 g       |      | 4.200 g                       |      |        |      |
|   | Ø 1000 mm   | 3.400 g        |      | 3.400 g       |      | 4.800 g                       |      |        |      |
|   | Ø 1200 mm   | 3.680 g        |      | 3.680 g       |      | 5.360 g                       |      |        |      |





berliner ring 2 up- und downlight im H-Profil  
berliner ring 2 up- and downlight in H-profile

Design: Martin Wallroth

br2-ud

LED-Band:

Ø 1000 mm: Ra > 80, Uplight 16 W, 2700 K/2400 lm, Downlight 48 W, 2700 K/5760 lm

Ø 2500 mm: Ra > 80, Uplight 30 W, 2700 K/4800 lm, Downlight 92 W, 2700 K/14400 lm

Ø 4600 mm: Ra > 80, Uplight 60 W, 2700 K/7400 lm, Downlight 92 W, 2700 K/21000 lm

Profil 70 x 80 mm (B x H)

LED strip:

Ø 1000 mm: Ra > 80, Uplight 16 W, 2700 K/2400 lm, Downlight 48 W, 2700 K/5760 lm

Ø 2500 mm: Ra > 80, Uplight 30 W, 2700 K/4800 lm, Downlight 92 W, 2700 K/14400 lm

Ø 4600 mm: Ra > 80, Uplight 60 W, 2700 K/7400 lm, Downlight 92 W, 2700 K/21000 lm

Profile 70 x 80 mm (W x H)

Gehäuse Housing



Individuelle Optionen auf Seite 52  
Customized options on page 52



br2-ud-r-1000

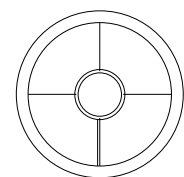
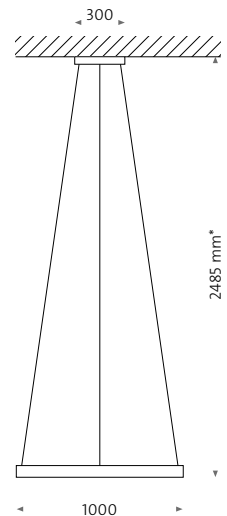

br2-ud-r-4600

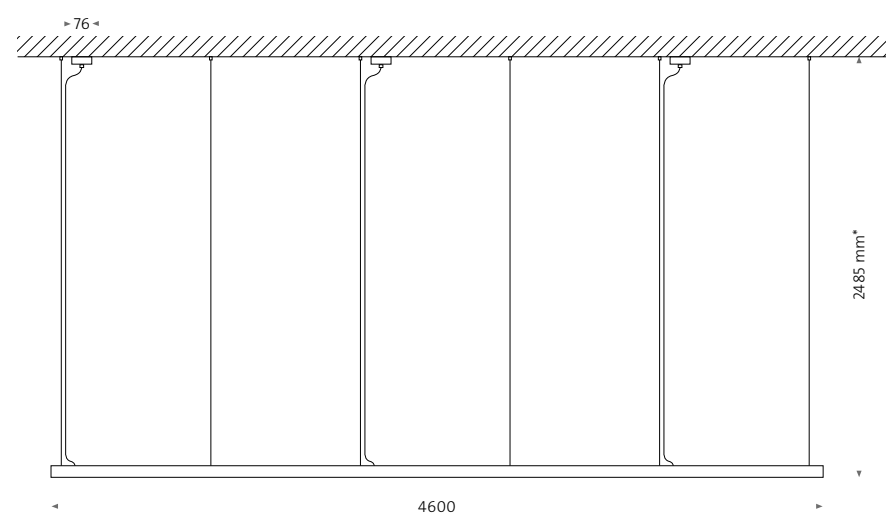

Exemplarische Darstellungen jeweils mit zentralem Baldachin (min. Ø 740 mm)  
und mit senkrechter Abpendelung (max. Ø 4600 mm)  
Exemplary illustrations each with central canopy (min. D 740 mm) and  
with vertical suspension (max. D 4600 mm).

\* Standardmaß Gesamtpendellänge Standard size total pendant length



berliner ring

Foto: Dirk Vogel

berliner ring 2 up- und downlight br2-ud Ø 2500 mm; Gemeindehaus Kleinmachnow  
berliner ring 2 up- and downlight br2-ud Ø 2500 mm; parish house Kleinmachnow



berliner ring 3 inlight im U-Profil  
berliner ring 3 inlight in U-profile

Design: Martin Wallroth

**br3-il**

LED-Band:

Ø 1200 mm: 103 W<sup>LED</sup>, 4000 K / 15740 lm

Ø 1500 mm: 129 W<sup>LED</sup>, 4000 K / 19675 lm

Ø 1800 mm: 155 W<sup>LED</sup>, 4000 K / 23610 lm

Ra > 80

Profil 70 × 100 mm (B × H)

LED strip:

Ø 1200 mm: 103 W<sup>LED</sup>, 4000 K / 15740 lm

Ø 1500 mm: 129 W<sup>LED</sup>, 4000 K / 19675 lm

Ø 1800 mm: 155 W<sup>LED</sup>, 4000 K / 23610 lm

Ra > 80

Profile 70 × 100 mm (W × H)

Gehäuse Housing



br3-il-r-1200

br3-il-r-1800

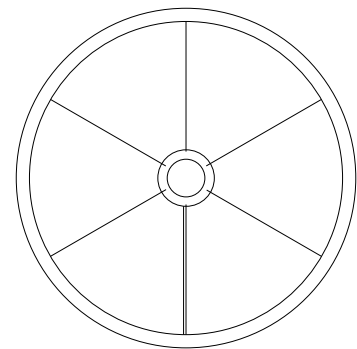
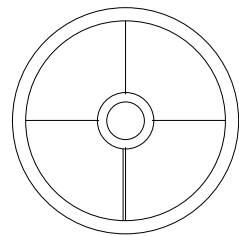
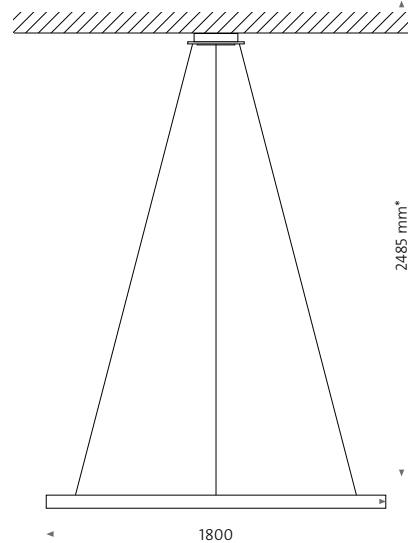
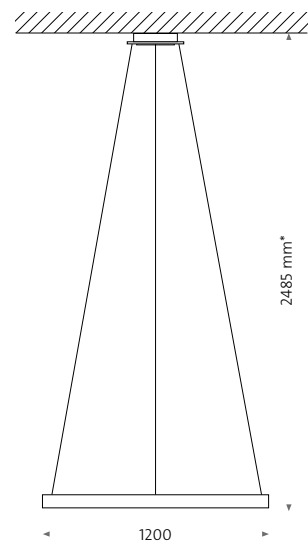

Individuelle Optionen auf Seite 53  
Customized options on page 53



\* Standardmaß Gesamtpendellänge Standard size total pendant length



Foto: Daniel Haym

berliner ring 3 inlight br3-il; Automobil-Kundenzentrum, Leipzig  
berliner ring 3 inlight br3-il; automobile customer center, Leipzig

Individuell gefertigter berliner ring 2 up- und downlight im H-Profil  
Customized berliner ring 2 up- and downlight in H-profile

Maßstab 1:15 Scale 1:15

br2-ud-l

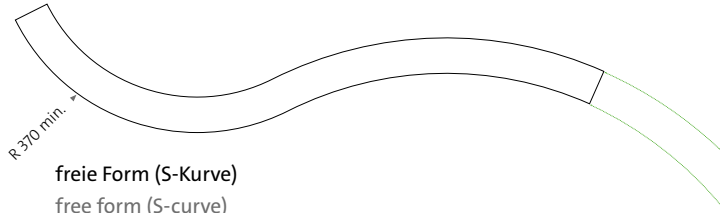

br2-ud-r-1000

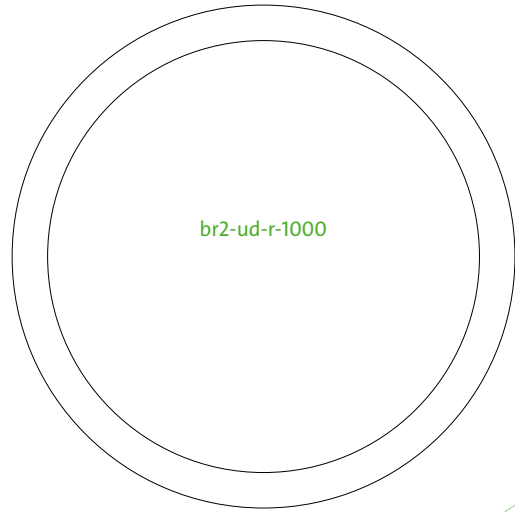

oval, individuelle Radiengrößen auf Anfrage (min. Ø 740)  
oval, individual radius sizes on request (min. Ø 740)

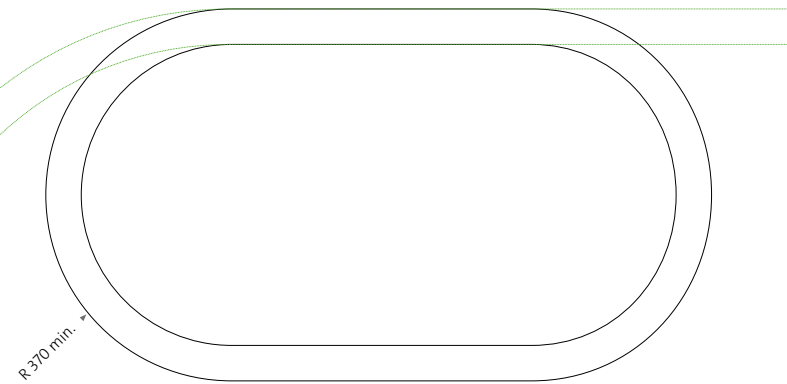

br2-ud-r-4600  
(min. Ø 4600)

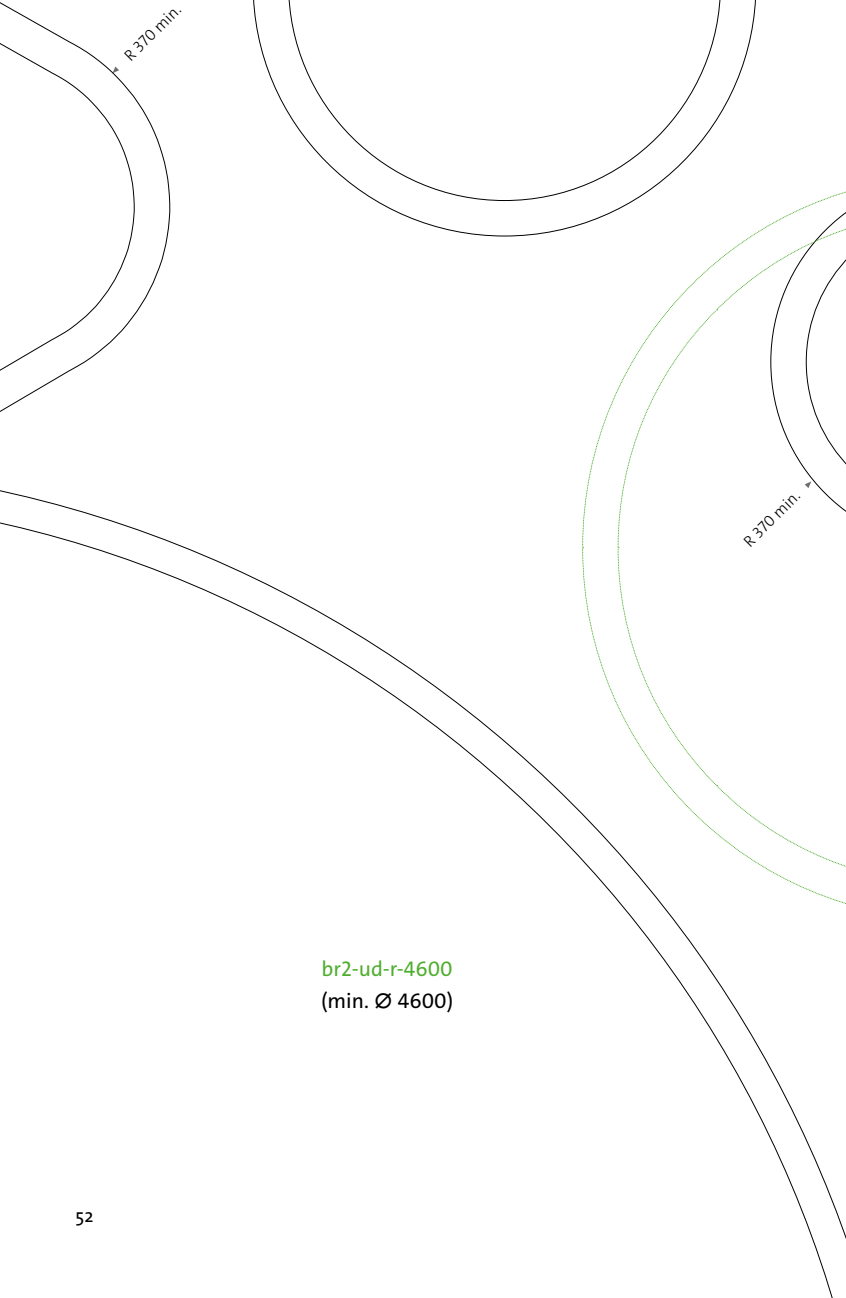

Individuell? Sprechen Sie uns gerne an.  
Customized? Feel free to contact us.

Individuell gefertigter berliner ring 3 inlight im U-Profil  
Customized berliner ring 3 inlight in U-profile

Maßstab 1:15 Scale 1:15

berliner ring

br3-il-r-1200  
(min. Ø 1200)

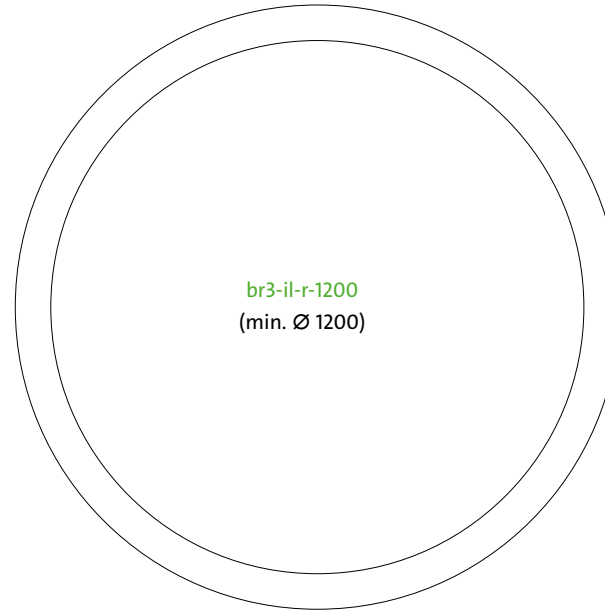

br3-il-r-1800

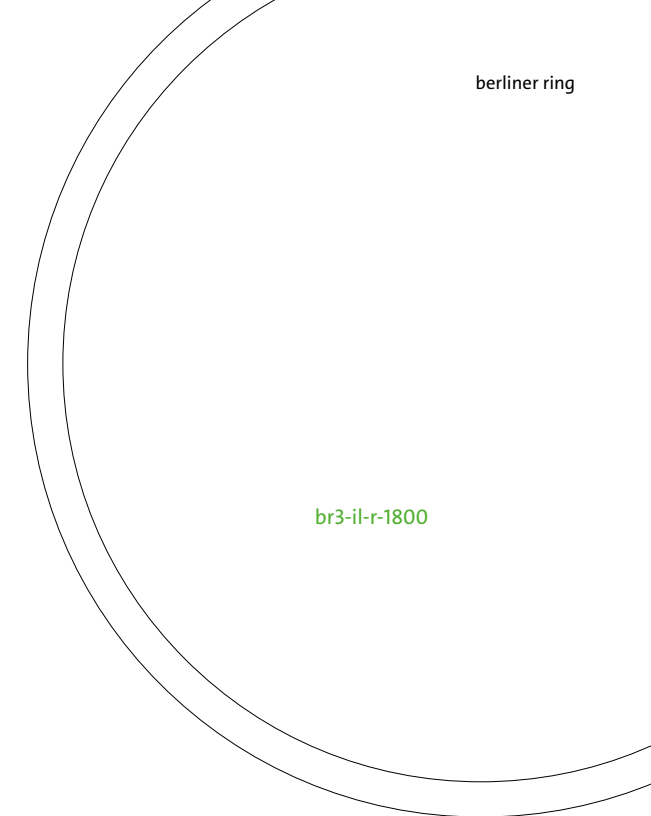

br3-il-l



oval, individuelle Radiengrößen auf Anfrage (min. Ø 1200)  
oval, individual radius sizes on request (min. Ø 1200)

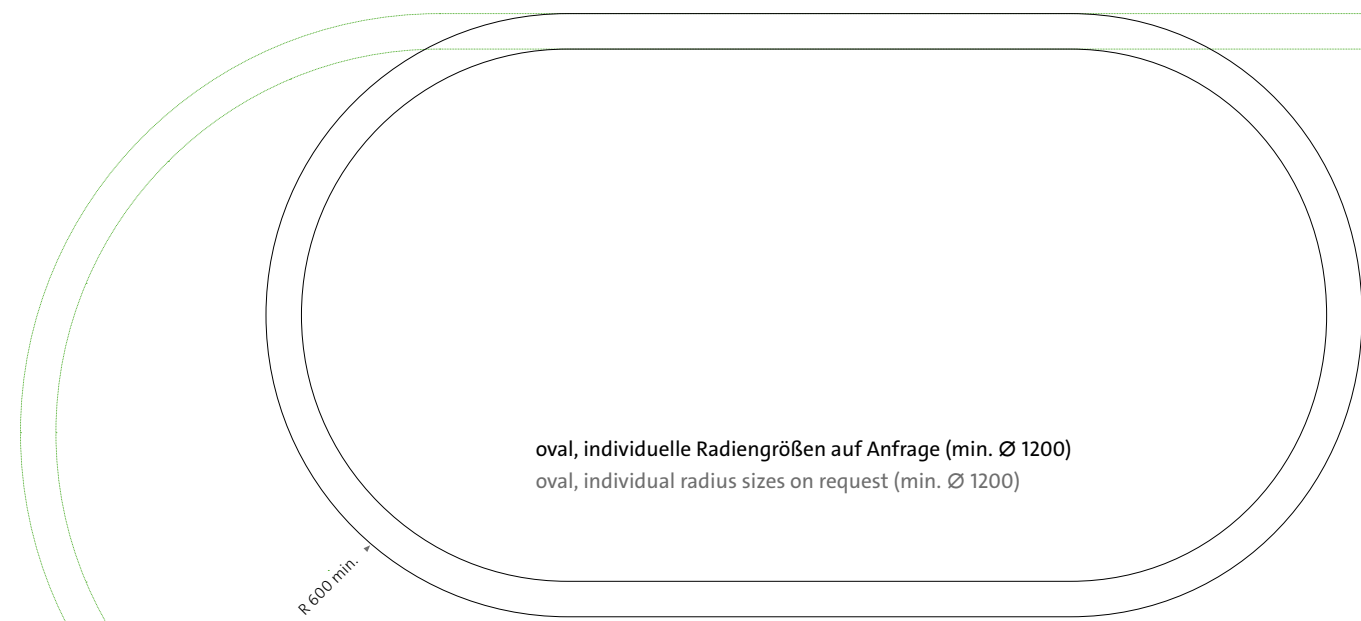

# bullauge

Die Abstraktion eines runden Schiffsfensters steht standardmäßig in verschiedenen Größen und Montagearten zur Auswahl. Auf Wunsch lassen sich auch individuelle Durchmesser, Lichtfarben und Pulverbeschichtungen realisieren. Die diffuse Abstrahlcharakteristik bereichert vor allem Räume, in denen großflächige und kontrastarme Beleuchtung benötigt wird.

*The abstraction of a round ship window is available in various sizes and types of installation. Individual diameters, light colors and powder coatings can be realized on request.*

*The diffuse radiation particularly enriches rooms in which wide and low-contrast lighting is required.*

## bullauge 5

Design: mawa

### bu5me

LED Modul:

Downlight: 65 W, 2700 K / 8600 lm, 3000 K / 9050 lm, Ra > 90 (typ. 92)

Uplight: 18 W, 2700 K / 2220 lm, 3000 K / 2328 lm, Ra > 90 (typ. 92)

dimmbar

LED module:

Downlight: 65 W, 2700 K / 8600 lm, 3000 K / 9050 lm, Ra > 90 (typ. 92)

Uplight: 18 W, 2700 K / 2220 lm, 3000 K / 2328 lm, Ra > 90 (typ. 92)

dimmbare

Gehäuse Housing

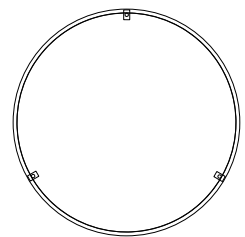
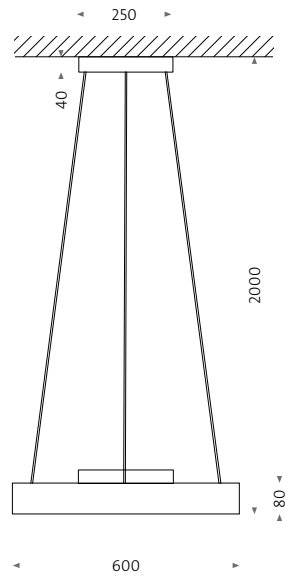







Design: Martin Wallroth

**bu6-450-G5**

LED Modul:

Downlight: 54 W, 2700 K / 6660 lm, 3000 K / 6988 lm, Ra > 90 (typ. 92)

Uplight: 12 W, 2700 K / 1480 lm, 3000 K / 1552 lm, Ra > 90 (typ. 92)

dimmbar

LED module:

Downlight: 54 W, 2700 K / 6660 lm, 3000 K / 6988 lm, Ra > 90 (typ. 92)

Uplight: 12 W, 2700 K / 1480 lm, 3000 K / 1552 lm, Ra > 90 (typ. 92)

dimmbable

Gehäuse Housing



bu6-450-G5-...-wm

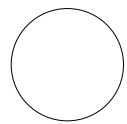
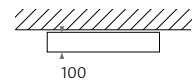

← 450 →

bu6-450-G5-...-wa  
bu6-450-G5-...-wa-u

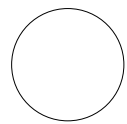
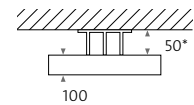

← 450 →

bu6-450-G5-...-p  
bu6-450-G5-...-p-u

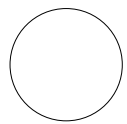
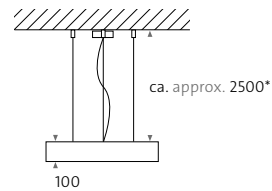

← 450 →



\* Standardmaß Standard size

Design: Martin Wallroth

**bu6-600-G5**

LED Modul:

Downlight: 65 W, 2700 K / 8600 lm, 3000 K / 9050 lm, Ra > 90 (typ. 92)

Uplight: 18 W, 2700 K / 2220 lm, 3000 K / 2328 lm, Ra > 90 (typ. 92)

dimmbar

LED module:

Downlight: 65 W, 2700 K / 8600 lm, 3000 K / 9050 lm, Ra > 90 (typ. 92)

Uplight: 18 W, 2700 K / 2220 lm, 3000 K / 2328 lm, Ra > 90 (typ. 92)

dimmbable

Gehäuse Housing



bu6-600-G5-...-wm

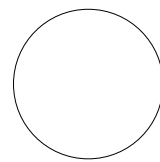
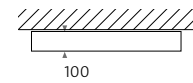

← 600 →

bu6-600-G5-...-wa  
bu6-600-G5-...-wa-u

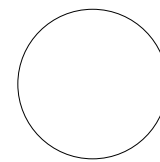
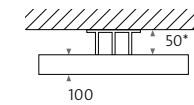

← 600 →

bu6-600-G5-...-p  
bu6-600-G5-...-p-u

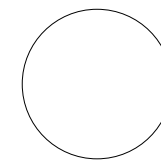
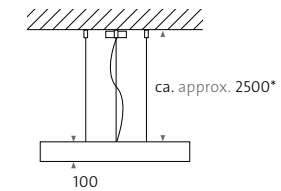

← 600 →



\* Standardmaß Standard size



Planung: möbel & raum GmbH, Michelstadt; Foto: Christian M. Stommel

bullauge



Foto: Stefan Wolf Lucks

links: individuell gefertigte bullauge 6 bu6-p-u Gehäuse schwarz; Energiegenossenschaft Odenwald  
left: customized bullauge 6 bu6-p-u housing black; Energiegenossenschaft Odenwald  
rechts: individuell gefertigte bullauge 6 bu6-wm Gehäuse orange; Waldkliniken Eisenberg  
right: customized bullauge 6 with orange housing bu6-wm; Waldkliniken Eisenberg

Design: Martin Wallroth

**bu6-800-G5**

LED Modul:  
 Downlight: 157 W, 2700 K / 21000 lm, 3000 K / 22070 lm, Ra > 90 (typ. 92)  
 Uplight: 24 W, 2700 K / 2960 lm, 3000 K / 3104 lm, Ra > 90 (typ. 92)  
 dimmbar  
 LED module:  
 Downlight: 157 W, 2700 K / 21000 lm, 3000 K / 22070 lm, Ra > 90 (typ. 92)  
 Uplight: 24 W, 2700 K / 2960 lm, 3000 K / 3104 lm, Ra > 90 (typ. 92)  
 dimmable

Gehäuse Housing



bu6-800-G5-...-wm

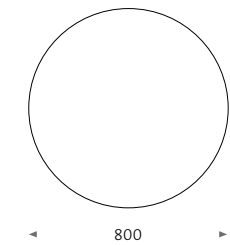
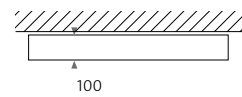

bu6-800-G5-...-wa  
 bu6-800-G5-...-wa-u

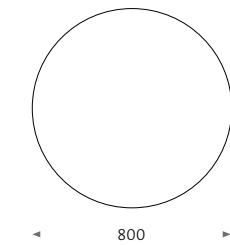
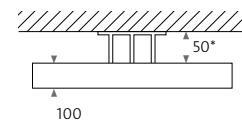

bu6-800-G5-...-p  
 bu6-800-G5-...-p-u

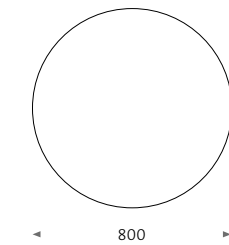
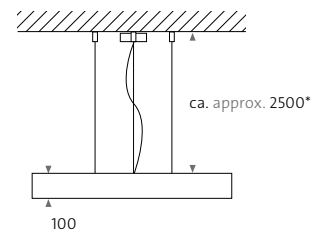

Design: Martin Wallroth

**bu6-1200-G4**

LED Modul:  
 Downlight: 147 W, 3000 K / 25424 lm, Ra > 80  
 Uplight: 34 W, 3000 K / 5790 lm, Ra > 80  
 dimmbar  
 LED module:  
 Downlight: 147 W, 3000 K / 25424 lm, Ra > 80  
 Uplight: 34 W, 3000 K / 5790 lm, Ra > 80  
 dimmable

Gehäuse Housing



bu6-1200-G4-...-wm

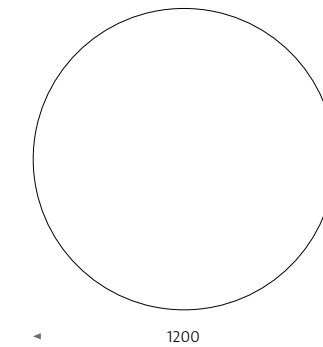
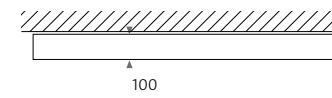

bu6-1200-G4-...-wa  
 bu6-1200-G4-...-wa-u

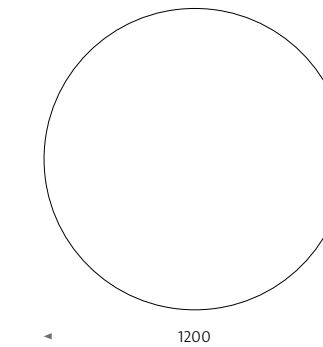
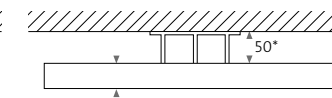

bu6-1200-G4-...-p  
 bu6-1200-G4-...-p-u

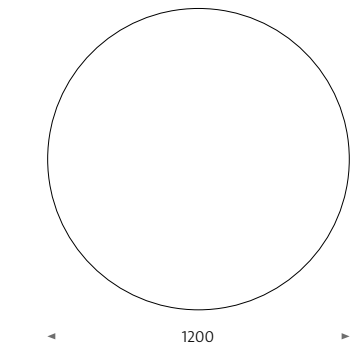
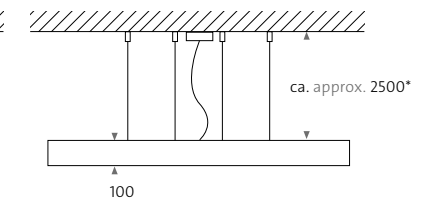

# bullauge 6 – Technische Informationen

## bullauge 6 – Technical information

**Material** Material  
 Aluminium pulverbeschichtet  
 Weiß matt, satiniertes Spezialplexiglas 3 mm  
 Aluminum powder coated  
 White matt, satin special plexiglass 3 mm

■ = verfügbar available  
 □ = auf Anfrage on request  
 □ = nicht verfügbar not available

bullauge

|  | bu6-450-G5   |  | bu6-600-G5   |  | bu6-800-G5   |  | bu6-1200-G4  |                                   |
|--|--|--|--|--|--|--|--|-----------------------------------|
| <b>Größe</b> Dimensions  | Ø 450 mm × 100 mm  |  | Ø 600 mm × 100 mm  |  | Ø 800 mm × 100 mm  |  | Ø 1200 mm × 100 mm   |                                   |
| <b>Montage</b> Mounting  | Wand- und Deckenmontage<br>Wall and ceiling-mounted -wm ■                                    |  | ■  |  | ■  |  | ■  |                                   |
|  | Wandanschlussplatte<br>Wall connecting plate -wa ■   |  | ■  |  | ■  |  | ■ (Standard-Wandabstand 50 mm)<br>(Standard wall distance 50 mm) |                                   |
|  | Wandanschlussplatte mit Uplight<br>Wall connecting plate with uplight -wa-u ■                |  | ■  |  | ■  |  | ■  |                                   |
|  | Pendelabhängung<br>Pendant light -p ■ (3-fach-Pendelabhängung)<br>(3-way pendant suspension) |  | ■ (3-fach-Pendelabhängung)<br>(3-way pendant suspension)           |  | ■ (3-fach-Pendelabhängung)<br>(3-way pendant suspension)             |  | ■ (4-fach-Pendelabhängung)<br>(4-way pendant suspension)         |                                   |
|  | Pendelabhängung mit Uplight<br>Pendant light with uplight -p-u ■                             |  | ■  |  | ■  |  | ■  |                                   |
| <b>Wattage</b>   | Downlight<br>54 W <sup>LED</sup>   | Uplight<br>12 W <sup>LED</sup>                                     | Downlight<br>65 W <sup>LED</sup>                                   | Uplight<br>18 W <sup>LED</sup>                                     | Downlight<br>157 W <sup>LED</sup>                                    | Uplight<br>24 W <sup>LED</sup>                                     | Downlight<br>147 W <sup>LED</sup>                                | Uplight<br>34 W <sup>LED</sup>    |
| <b>Lichtfarbe / Lichtstrom</b><br>Light colors / Luminous flux | 2700 K / 6660 lm <sup>LED</sup><br>3000 K / 6988 lm <sup>LED</sup>                           | 2700 K / 1480 lm <sup>LED</sup><br>3000 K / 1552 lm <sup>LED</sup> | 2700 K / 8600 lm <sup>LED</sup><br>3000 K / 9050 lm <sup>LED</sup> | 2700 K / 2220 lm <sup>LED</sup><br>3000 K / 2328 lm <sup>LED</sup> | 2700 K / 21000 lm <sup>LED</sup><br>3000 K / 22070 lm <sup>LED</sup> | 2700 K / 2960 lm <sup>LED</sup><br>3000 K / 3104 lm <sup>LED</sup> | □ 3000 K / 25424 lm <sup>LED</sup>                               | □ 3000 K / 5790 lm <sup>LED</sup> |
| <b>Farbwiedergabeindex</b><br>Color rendering index            | Ra > 90 (typ. 92)  |  | Ra > 90 (typ. 92)  |  | Ra > 90 (typ. 92)  |  | Ra > 80  |                                   |
| <b>Lebensdauer LED</b> Lifetime LED                            | L80 > 54.000 h (IES LM-80/TM-21)   |  | L80 > 54.000 h (IES LM-80/TM-21)                                   |  | L80 > 54.000 h (IES LM-80/TM-21)                                     |  | L80 > 54.000 h (IES LM-80/TM-21)                                 |                                   |
| <b>Steuerung</b> Controller                                    | DALI -4 ■  |  | ■  |  | ■  |  | ■  |                                   |
|  | Phasenanschnitt/-abschnitt<br>Leading edge/trailing edge -7 ■                                |  | ■  |  | ■  |  | ■  |                                   |
|  | Bluetooth -9 ■   |  | ■  |  | ■  |  | ■  |                                   |
| <b>Gewicht</b><br>Weight                                       | bu6-450-wm 4,5 kg<br>bu6-450-wa 5,0 kg<br>bu6-450-p 4,5 kg                                   |  | bu6-600-wm 9,0 kg<br>bu6-600-wa 9,5 kg<br>bu6-600-p 9,0 kg         |  | bu6-800-wm 12,0 kg<br>bu6-800-wa 12,5 kg<br>bu6-800-p 12,0 kg        |  | bu6-1200-wm 25,0 kg<br>bu6-1200-wa 26,0 kg<br>bu6-1200-p 25,0 kg |                                   |

# one piece

Die wandmontierten Deckenfluter sind formal auf das technisch Notwendige reduziert und lassen sich unscheinbar in jedes Interieur integrieren. Aus einem Stück Aluminium gefaltet überzeugen die Gehäuse mit präzisen Kanten und sind, abhängig von ihrer Leistungsklasse, in vier verschiedenen Größen und individueller Pulverbeschichtung erhältlich.

*The wall-mounted ceiling washers are formally reduced to what is technically necessary and can be inconspicuously integrated into any interior. Folded from one piece of aluminum, the housings convince with precise edges and are available in four different sizes and individual powder coating, depending on their performance class.*

one piece 6 / 7

Design op6: Martin Wallroth  
Design op7: Tan Aksoy, Martin Wallroth

op6  
op7

LED op6: 24 W, 2700 K / 1533 lm, 3000 K / 1592 lm, 4000 K / 1703 lm, Ra > 90 (typ. 92)  
LED op7: 19 W, 2700 K / 1620 lm, 3000 K / 1700 lm, 4000 K / 1900 lm, Ra > 90 (typ. 92)

dimmbar

LED op6: 24 W, 2700 K / 1533 lm, 3000 K / 1592 lm, 4000 K / 1703 lm, Ra > 90 (typ. 92)  
LED op7: 19 W, 2700 K / 1620 lm, 3000 K / 1700 lm, 4000 K / 1900 lm, Ra > 90 (typ. 92)  
dimmable

Gehäuse Housing



op6

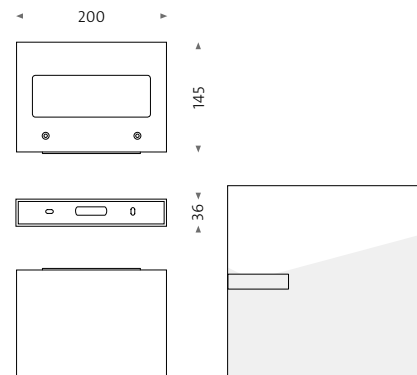

op7

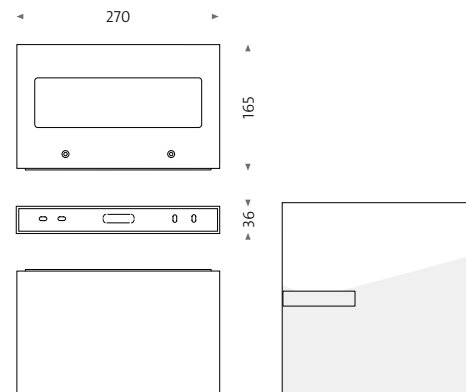

op6



op7





Design op8: Tan Aksoy, Martin Wallroth  
Design op9: Martin Wallroth

op8  
op9

LED op8: 43 W, 2700 K / 3240 lm, 3000 K / 3400 lm, 4000 K / 3800 lm, Ra > 90 (typ. 92)  
LED op9: 86 W (93 W bei Phasen- und abschnittsdimmung), 2700 K / 7650 lm, 3000 K / 8000 lm, 4000 K / 8200 lm, Ra > 90 (typ. 92)

dimmbar

LED op8: 43 W, 2700 K / 3240 lm, 3000 K / 3400 lm, 4000 K / 3800 lm, Ra > 90 (typ. 92)  
LED op9: 86 W (93 W on leading and trailing edge dimming), 2700 K / 7650 lm, 3000 K / 8000 lm, 4000 K / 8200 lm, Ra > 90 (typ. 92)  
dimmable

Gehäuse Housing



op8

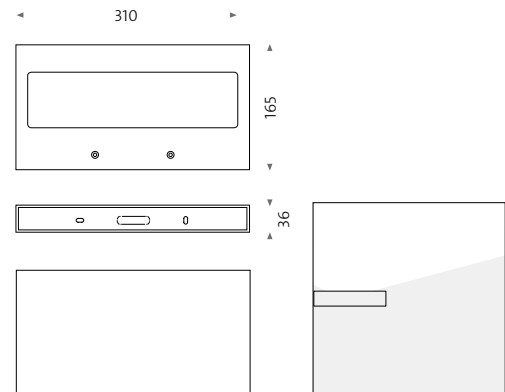

op9



op8



op9





# one piece – Technische Informationen

## one piece – Technical information

**Material** Material  
Aluminium pulverbeschichtet  
Aluminum powder coated

■ = verfügbar available  
 ■ = auf Anfrage on request  
 □ = nicht verfügbar not available

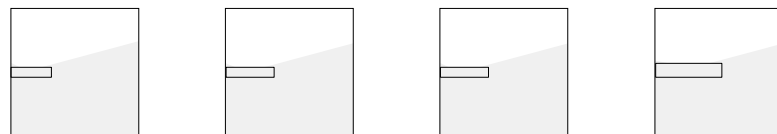

op6

op7

op8

op9

|  |  |  |  |  |
|--|--|--|--|--|
| <b>Größe in mm (L × B × H)</b><br>Dimensions in mm (L × W × H) | 200 × 145 × 36   | 270 × 165 × 36   | 310 × 165 × 36   | 360 × 200 × 54   |
| <b>Leuchtenart</b><br>Luminaire type                           | Deckenfluter<br>Ceiling washer                           | Deckenfluter<br>Ceiling washer                           | Deckenfluter<br>Ceiling washer                           | Deckenfluter<br>Ceiling washer                           |
| <b>Montage</b><br>Mounting                                     | Aufbau<br>Surface-mounted                                | Aufbau<br>Surface-mounted                                | Aufbau<br>Surface-mounted                                | Aufbau<br>Surface-mounted                                |
| <b>Anschlussleistung</b><br>Connected load                     | Uplight<br>24 W  | Uplight<br>19 W  | Uplight<br>43 W  | Uplight<br>86 W (-4)<br>93 W (-7)                        |
| <b>Lichtfarbe / Lichtstrom</b><br>Light colors / Luminous flux | 2700 K / 1533 lm<br>3000 K / 1592 lm<br>4000 K / 1703 lm | 2700 K / 1620 lm<br>3000 K / 1700 lm<br>4000 K / 1900 lm | 2700 K / 3240 lm<br>3000 K / 3400 lm<br>4000 K / 3800 lm | 2700 K / 7650 lm<br>3000 K / 8000 lm<br>4000 K / 8200 lm |
| <b>Farbwiedergabeindex</b><br>Color rendering index            | Ra > 90 (typ. 92)  | Ra > 90 (typ. 92)  | Ra > 90 (typ. 92)  | Ra > 90 (typ. 92)  |
| <b>Lebensdauer LED</b><br>Lifetime LED                         | L90 > 55.000 h<br>(IES LM-80/TM-21)                      | L90 > 55.000 h<br>(IES LM-80/TM-21)                      | L90 > 55.000 h<br>(IES LM-80/TM-21)                      | L90 (10k) > 55.000 h<br>(IES LM-80/TM-21)                |
| <b>Steuerung Controller</b>                                    | DALI -4 ■  | ■  | ■  | ■  |
| Phasenanschnitt/-abschnitt<br>Leading edge/trailing edge       | -7 ■   | ■  | ■  | ■  |
| Bluetooth  | -9 ■   | ■  | ■  | ■  |
| <b>Gewicht Weight</b>  | 920 g  | 1.400 g  | 1.700 g  | 3.000 g  |



Individuell gefertigte one piece 8 für die Kreuzkirche Dresden  
Customized one piece 8 for Kreuzkirche Dresden

LED:

Uplight 4 x 9 W, 350 mA

Downlight 1 x 8 W, 350 mA

Abdeckung Downlight satiniert oder prismatisches Acryl

Uplight 4 x 9 W, 350 mA

Downlight 1 x 8 W, 350 mA

Cover downlight satin or prismatic acrylic



Foto: Stefan Järmer

individuell gefertigte Leuchten basierend auf der one piece 8 op8; Kreuzkirche Dresden  
customized luminaires based on one piece 8 op8; Kreuzkirche Dresden

Individuell gefertigte one piece 9 für die Herz-Jesu-Kirche, Berlin  
Customized one piece 9 for the Herz-Jesu-Kirche, Berlin

LED:

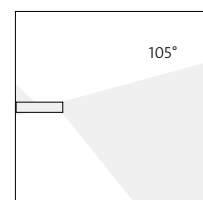
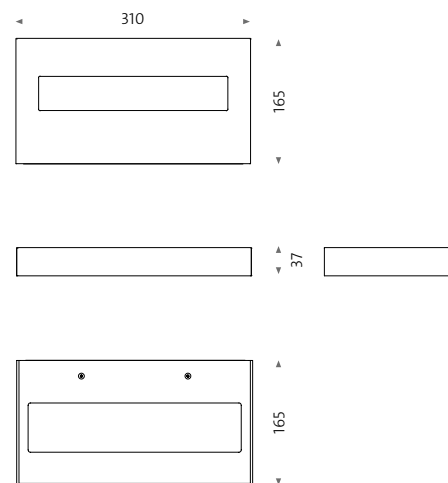
Uplight 86 W, 3000 K / 8000 lm

dimmbar

Downlight 4 × fbl-Lichteinheit, gesamt 68W, 3000 K / 3700 lm,

Linseneinheit 45°, Diffusor 40°

LED:

Uplight 86 W, 3000 K / 8000 lm

dimmbare

Downlight 4 × fbl light unit, total 68W, 3000 K / 3700 lm,

lens unit 45°, diffuser 40°

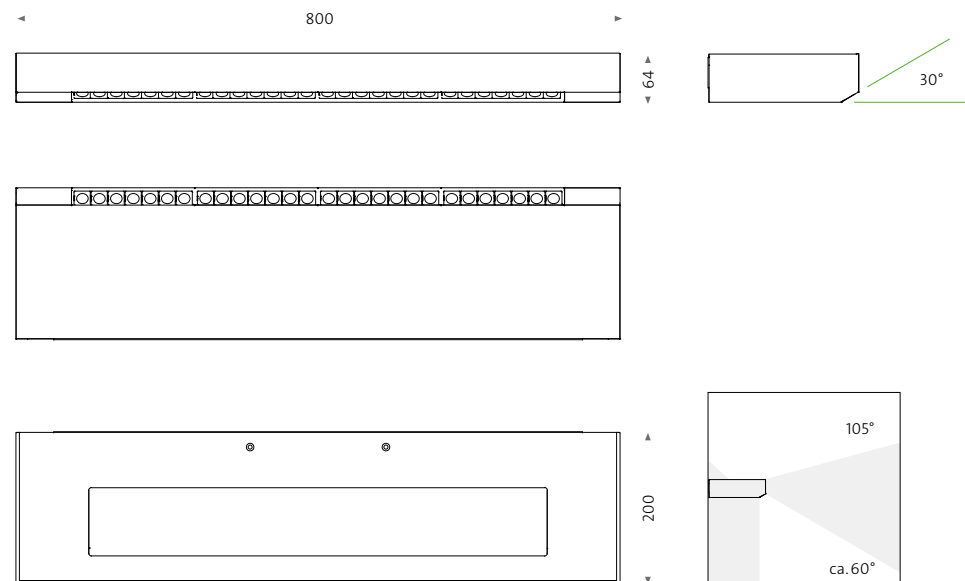

one piece

Foto: Stefan Wolf Lucks

individuell gefertigte Leuchten basierend auf der one piece 9 op9 und der Serie fbl; Herz-Jesu-Kirche, Berlin  
customized luminaires based on one piece op 9 op9 and series fbl; Herz-Jesu-Kirche, Berlin

Individuell gefertigte one piece 8 für Burg Vischering  
 Customized one piece 8 for Burg Vischering

LED:  
 Uplight 43 W, 3000 K/3400 lm  
 dimmbar  
 Downlight 2 × wittenberg 4.0-Lichteinheit, je 12,7 W, 3000 K/1300 lm, 24°  
 Notlichtüberwachungsmodul  
 LED:  
 Uplight 43 W, 3000 K/3400 lm  
 dimmable  
 Downlight 2 × wittenberg 4.0 light unit, each 12.7 W, 3000 K/1300 lm, 24°  
 Emergency light monitoring module

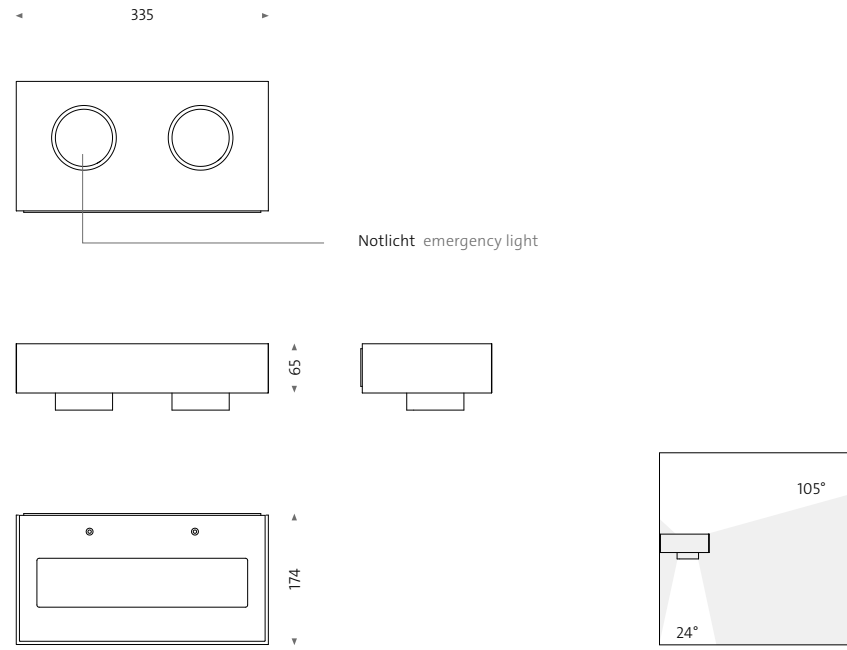

one piece

Foto: Philipp Obkircher

individuell gefertigte Leuchten basierend auf der one piece 8 op8 und der Serie wittenberg 4.0; Museum Burg Vischering, Lüdinghausen  
 customized luminaires based on one piece 8 op8 and series wittenberg 4.0; Museum Castle Vischering, Lüdinghausen

# oval office

Die seriellen Decken-, Pendel- und Wandleuchten überzeugen mit zeitloser Eleganz. Mit ihren abgerundeten Enden und ihrer schlichten Form lassen sie sich mit nahezu jedem Interieur kombinieren. Auf einem individuell gebogenen Strangpressprofil basierend, lassen sich eine Vielzahl von Komponenten integrieren und auf Wunsch Sonderlängen umsetzen.

*The serial ceiling, pendant and wall lights impress with timeless elegance. With their rounded ends and simple shape, they can be combined with almost any interior. Based on an individually bent extruded profile, numerous components can be integrated and special lengths are viable on request.*



Design: Marco Schölzel, Martin Wallroth

ov3

ov4

LED:

ov3: 8,3 W, 2700 K/1000 lm, 3000 K/1100 lm, Ra > 90

ov4: 16,6 W, 2700 K/2000 lm, 3000 K/2200 lm, Ra > 90

dimmbar

LED:

ov3: 8.3 W, 2700 K/1000 lm, 3000 K/1100 lm, Ra > 90

ov4: 16.6 W, 2700 K/2000 lm, 3000 K/2200 lm, Ra > 90

dimmable

Gehäuse Housing



ov3

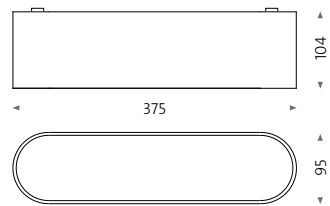

ov4

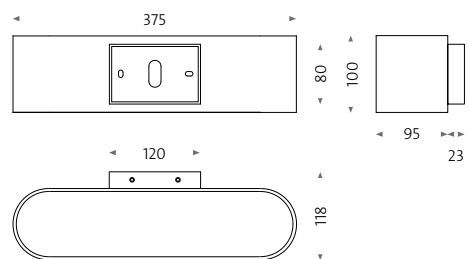

ov3



ov4



## oval office 7/8

Design: Marco Schölzel, Martin Wallroth

### ov7 ov8

LED:

ov7: 9 W, 2700 K/1000 lm, 3000 K/1100 lm, Ra > 90

ov8: 34 W, 2700 K/3000 lm, 3000 K/4400 lm, Ra > 90

dimmbar

LED:

ov7: 9 W, 2700 K/1000 lm, 3000 K/1100 lm, Ra > 90

ov8: 34 W, 2700 K/3000 lm, 3000 K/4400 lm, Ra > 90

dimmable

Gehäuse Housing



### ov7

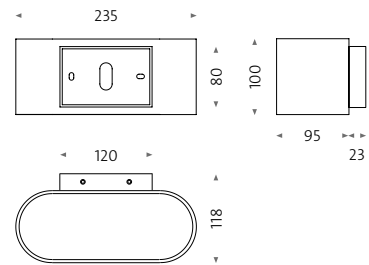

### ov8

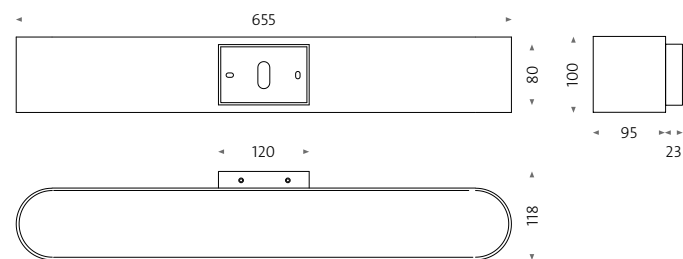

### ov7



### ov8





oval office 5/6

Design: Marco Schölzel, Martin Wallroth

ov5  
ov6

LED:  
ov5: 34 W, 2700 K/4000 lm, 3000 K/4400 lm, Ra > 90  
ov6: 26 W, 2700 K/3000 lm, 3000 K/3300 lm, Ra > 90  
dimmbar

Kabel: 2,00 m

LED:  
ov5: 35 W, 2700 K/4000 lm, 3000 K/4400 lm, Ra > 90  
ov6: 26 W, 2700 K/3000 lm, 3000 K/3300 lm, Ra > 90  
dimmable

Cable: 2.50 m

Gehäuse Housing



ov5

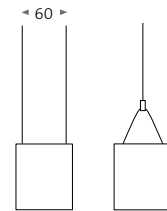
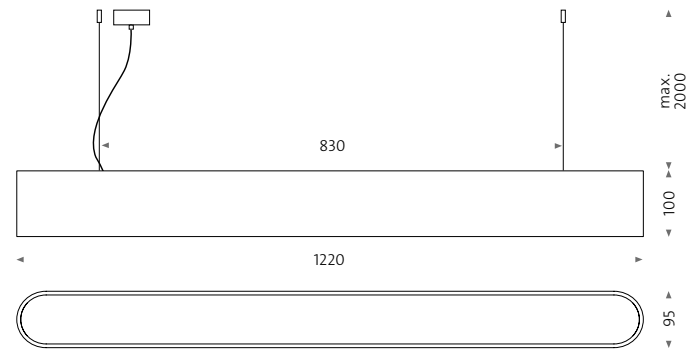

optional Y-Abhänger möglich  
optional Y-shaped wire suspension available

ov6

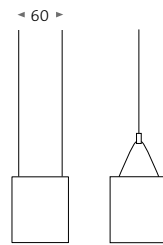
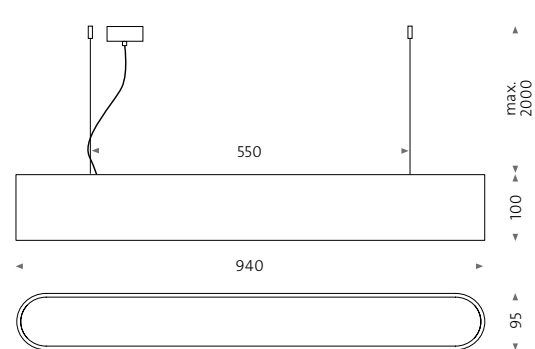

optional Y-Abhänger möglich  
optional Y-shaped wire suspension available

ov5



ov6



# oval office – Technische Informationen

## oval office – Technical information

**Material** Material  
 Aluminium pulverbeschichtet  
 Satiniertes Acrylglas  
 Aluminum powder coated  
 Satin acrylic glass

■ = verfügbar available  
 □ = auf Anfrage on request  
 □ = nicht verfügbar not available

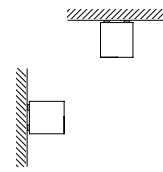

ov3

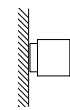

ov4

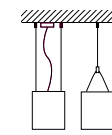

ov5

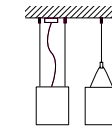

ov6

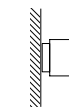

ov7

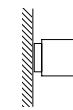

ov8

| Größe in mm (L × B × H)<br>Dimensions in mm (L × W × H)        | 375 × 95 × 104   | 375 × 118 × 100  | 1220 × 95 × 100  | 940 × 95 × 100   | 235 × 118 × 100  | 655 × 118 × 100  |
|--|--|--|--|--|--|--|
| <b>Leuchtenart</b><br>Luminaire type                           | Decken- und Wandleuchte<br>Ceiling and wall light                  | Wandleuchte<br>Wall light  | Pendelleuchte<br>Pendant light                                     | Pendelleuchte<br>Pendant light                                     | Wandleuchte<br>Wall light  | Wandleuchte<br>Wall light  |
| <b>Montage</b><br>Mounting                                     | Aufbau<br>Surface-mounted  | Aufbau<br>Surface-mounted  | Aufbau<br>Surface-mounted  | Aufbau<br>Surface-mounted  | Aufbau<br>Surface-mounted  | Aufbau<br>Surface-mounted  |
| <b>Wattage LED</b>   | Downlight<br>8,3 W <sup>LED</sup>                                  | Downlight / Uplight<br>16,6 W <sup>LED</sup>                       | Downlight / Uplight<br>34 W <sup>LED</sup>                         | Downlight / Uplight<br>26 W <sup>LED</sup>                         | Downlight / Uplight<br>9 W <sup>LED</sup>                          | Downlight / Uplight<br>34 W <sup>LED</sup>                         |
| <b>Lichtfarbe / Lichtstrom</b><br>Light colors / Luminous flux | 2700 K / 1000 lm <sup>LED</sup><br>3000 K / 1100 lm <sup>LED</sup> | 2700 K / 2000 lm <sup>LED</sup><br>3000 K / 2200 lm <sup>LED</sup> | 2700 K / 4000 lm <sup>LED</sup><br>3000 K / 4400 lm <sup>LED</sup> | 2700 K / 3000 lm <sup>LED</sup><br>3000 K / 3300 lm <sup>LED</sup> | 2700 K / 1000 lm <sup>LED</sup><br>3000 K / 1100 lm <sup>LED</sup> | 2700 K / 3000 lm <sup>LED</sup><br>3000 K / 4400 lm <sup>LED</sup> |
| <b>Farbwiedergabeindex</b><br>Color rendering index            | Ra > 90  | Ra > 90  | Ra > 90  | Ra > 90  | Ra > 90  | Ra > 90  |
| <b>Lebensdauer LED</b><br>Lifetime LED                         | L80 > 54.000 h<br>(IES LM-80 / TM-21)                              | L80 > 54.000 h<br>(IES LM-80 / TM-21)                              | L80 > 54.000 h<br>(IES LM-80 / TM-21)                              | L80 > 54.000 h<br>(IES LM-80 / TM-21)                              | L80 > 54.000 h<br>(IES LM-80 / TM-21)                              | L80 > 54.000 h<br>(IES LM-80 / TM-21)                              |
| <b>Steuerung Controller</b>                                    | DALI -4 ■  | ■  | ■  | ■  | ■  | ■  |
| Phasenanschnitt/-abschnitt<br>Leading edge/trailing edge       | -7 ■   | ■  | ■  | ■  | ■  | ■  |
| <b>Gewicht Weight</b>  | 1.400 g  | 1.400 g  | 4.400 g  | 3.400 g  | 1.000 g  | 2.100 g  |

# Tisch- und Stehleuchten

## *Table and floor lamps*

Beste Bedingungen zum Lesen und Lernen hat mawa bereits in vielen öffentlichen Einrichtungen und Bibliotheken geschaffen. Schlichte Leuchtenmodellen, modifizierte Reflektortechnik, individuelle Tasterlösungen und maßgeschneiderte Tischanbindungen samt integrierter Steckdoseneinheit sind umsetzbar.

*In many public institutions and libraries mawa has already created the best conditions for reading and learning. Modest luminaire models, modified reflector technology, individual pushbutton solutions and customized table connections including integrated socket units can be implemented.*

## elle 1

Design: Martin Wallroth

## el1

LED: 6 W, 2700 K / 500 lm, 3000 K / 520 lm, 4000 K / 550 lm, Ra 90

Bodenplatte mit integrierter Steck- oder Datendose optional

Befestigung an Tischplatte mit max. 55 mm Stärke (Bauraum unterhalb min. 100 mm)

LED: 6 W, 2700 K / 500 lm, 3000 K / 520 lm, 4000 K / 550 lm, Ra 90

Base plate with integrated electrical or data socket optional

Attachment to tabletop with max. 55 mm thickness (installation space below min. 100 mm)

Gehäuse Housing

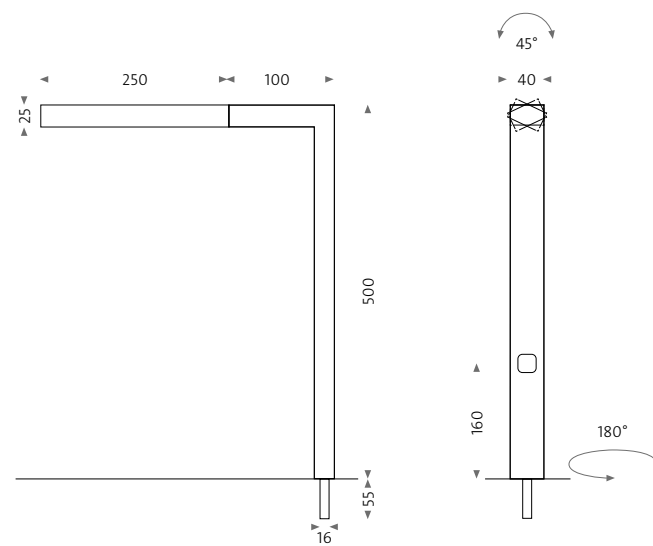



elle 2

Design: Martin Wallroth

el2

LED: 6 W, 2700 K / 500 lm, 3000 K / 520 lm, 4000 K / 550 lm, Ra 90  
LED: 6 W, 2700 K / 500 lm, 3000 K / 520 lm, 4000 K / 550 lm, Ra 90

Gehäuse Housing



Fuß Base

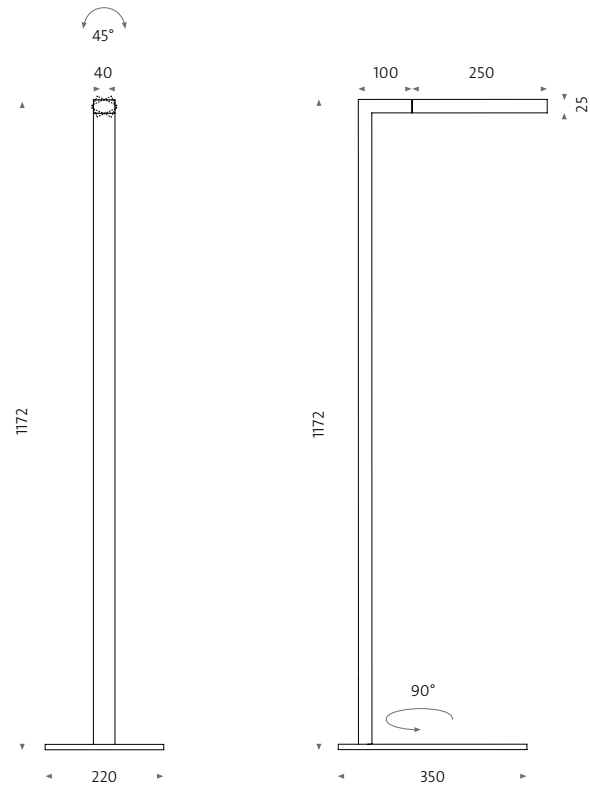

Architektur: Rem Koolhaas/OMA; Foto: Ossip van Duivenbode



elle 4

Design: Martin Wallroth

e14

LED: 2 x 6 W, 2700 K/1000 lm, 3000 K/1040 lm, 4000 K/1100 lm, Ra 90

Bodenplatte mit integrierter Steck- oder Datendose optional

LED: 2 x 6 W, 2700 K/1000 lm, 3000 K/1040 lm, 4000 K/1100 lm, Ra 90

Base plate with integrated electrical or data socket optional

Gehäuse Housing

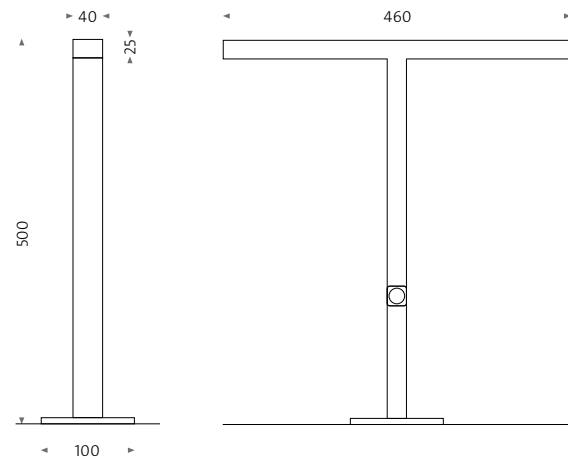

Architektur: Florian Nagler Architekten, Foto: mawa

elle 4 e14; Campusbibliothek Freien Universität Berlin  
elle 4 e14; campus library Freie Universität Berlin



grimm

Design: Max Dudler Architekten

gz1

Downlight LED: 6 W, 3000 K / 845 lm, 4000 K / 870 lm, Ra 90  
Uplight LED: 6 W, 3000 K / 845 lm, 4000 K / 870 lm, Ra 90  
Bodenplatte mit integrierter Steck- oder Datendose optional  
Downlight LED: 6 W, 3000 K / 845 lm, 4000 K / 870 lm, Ra 90  
Uplight LED: 6 W, 3000 K / 845 lm, 4000 K / 870 lm, Ra 90  
Base plate with integrated electrical or data socket optional

Gehäuse Housing

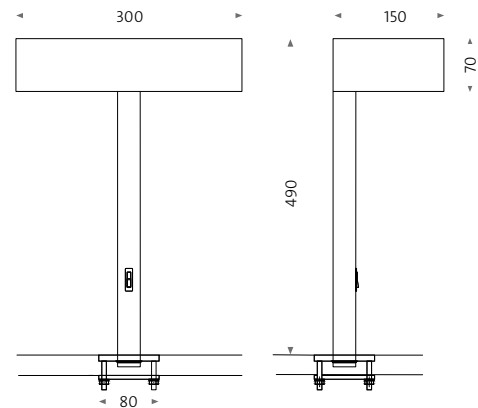

Architektur: Max Dudler GmbH; Foto: Stefen Müller

grimm gzm1; Bibliothek Folkwang Universität der Künste, Essen  
grimm gzm1; library Folkwang University of the Arts, Essen

potsdam

Design: Marco Schölzel, Martin Wallroth

po1

LED: 25 W, 3000 K / 2500 lm

Bodenplatte mit integrierter Steck- oder Datendose optional

Anpassung der Lichtaustrittscharakteristik möglich

für bis zu vier Arbeitsplätze einsetzbar

LED: 25 W, 3000 K / 2500 lm

Base plate with integrated electrical or data socket optional

Adjustment of the light emission characteristic possible

can be used for up to four workstations

Gehäuse Housing



Foto: Till Schuster



Tisch- und Stehleuchten Table and floor lamps

Fotos: Till Schuster (links), Marcus Ebener (rechts)

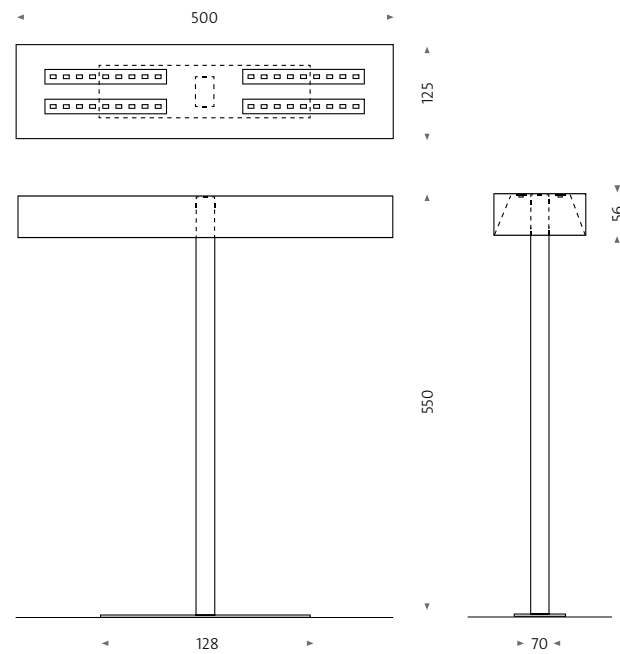
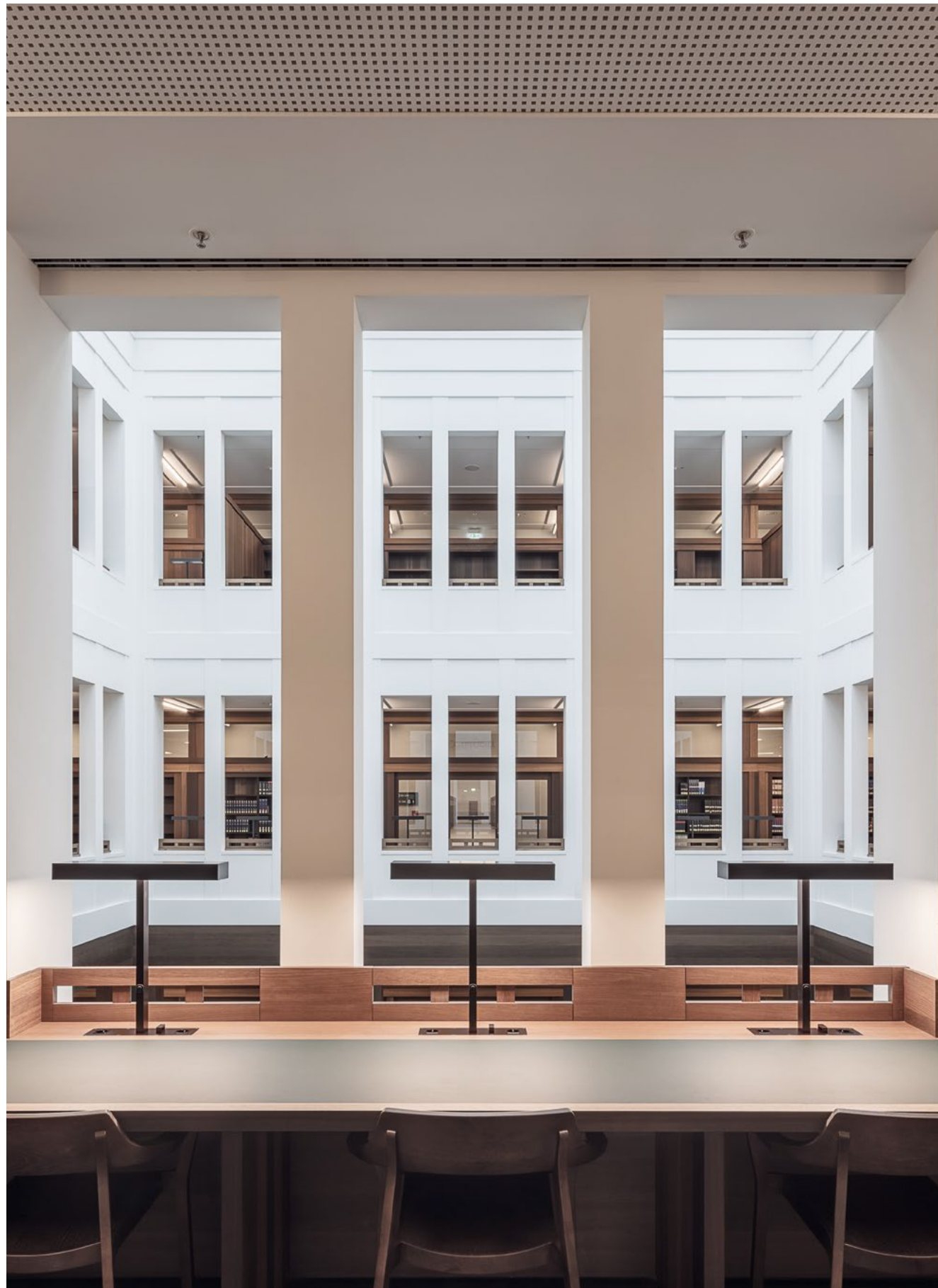
links: potsdam po1; Universitätsbibliothek TU Chemnitz  
left: potsdam po1; University library TU Chemnitz  
rechts: elle 1 e11 und potsdam po1; Universitätsbibliothek im IKMZ Golm, Potsdam  
right: elle 1 e11 und potsdam po1; University library at IKMZ Golm, Potsdam

# langer kerl

Design: Marco Schölzel, Martin Wallroth

## lk1

LED: 56 W, 3000 K / 4500 lm (2700 K, 4000 K auf Anfrage), Ra 90  
mit geprüftem Standsicherheitsnachweis

optional dimmbar

LED: 56 W, 3000 K / 4500 lm (2700 K, 4000 K on request), Ra 90  
with certified proof of stability  
optional dimmable

Gehäuse Housing



Foto: ma/wa

langer kerl lk1; Museum Schloss Schönhausen, Berlin  
langer kerl lk1; museum castle Schönhausen, Berlin

basel

Design: Marco Schölzel, mawa, Edwin Smida

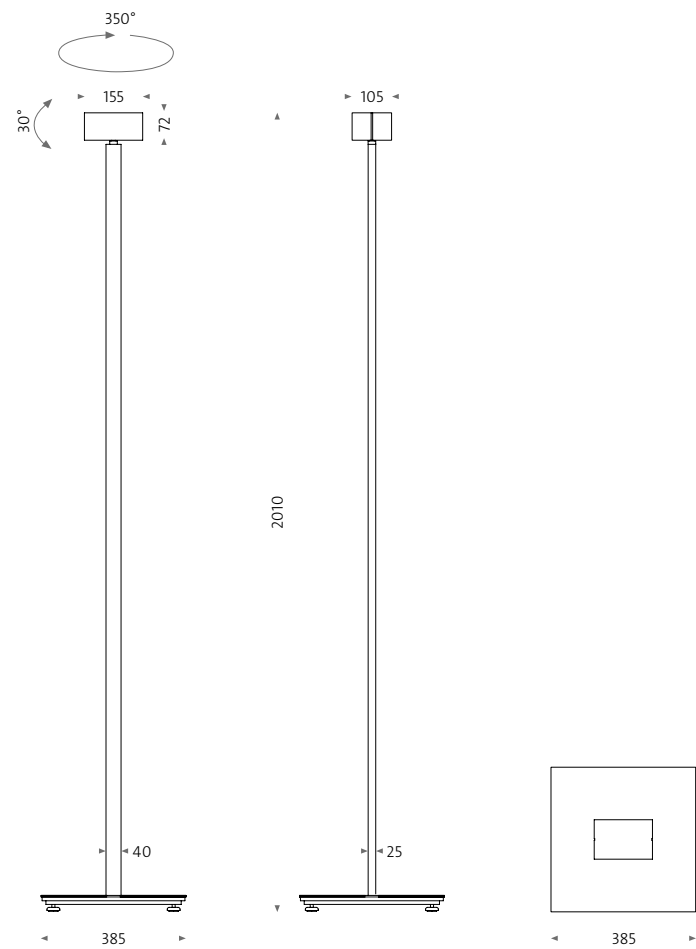
### ba1

LED: 92 W, 3000 K / 12100 lm, 4000 K / 12500 lm,  
Ra >90 (typ.92), Ra >95 (typ. 97)

Kabel: 3,60 m, aufrollbar im Leuchtenfuß  
dimmbar

LED: 92 W, 3000 K / 12100 lm, 4000 K / 12500 lm,  
Ra >90 (typ.92), Ra >95 (typ. 97)

dimmbare

Cable: 3.60 m, rollable in the lamp base

Gehäuse Housing



Foto: Steffen Jaenicke

# Pendelleuchten

## *Pendant lights*

In Foyers, Arkaden oder Entrées entfalten Pendelleuchten ihre volle Wirkung. Sie bieten lichttechnische Lösungen für jede architektonische Situation und zeigen zugleich eine hohe Ästhetik, die den Raum akzentuiert.

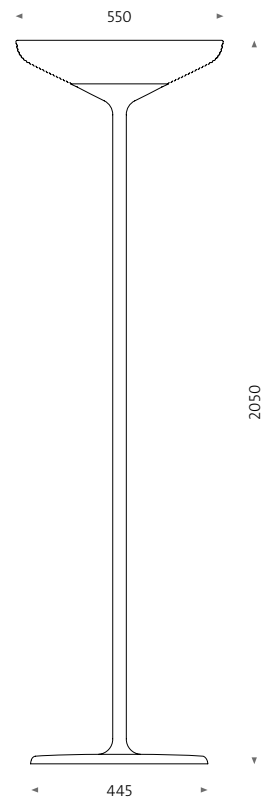
*In foyers, arcades or entrées, pendant luminaires unfold their full effect. They offer lighting solutions for any architectural situation and at the same time show high aesthetics that accentuate the room.*

# charlottenburg

Design: Kardorff Ingenieure Lichtplanung Berlin  
Engineering: mawa

## ch600 ch900

Downlight:  
LED 12,7 W, 2700 K/1100 lm, 3000 K/1200 lm,  
4000 K/1350 lm, Ra > 90 (typ. 92)

Uplight ch600:  
LED 30 W, 3000 K/3700 lm, Ra 90

Uplight ch900:  
LED 60 W, 3000 K/7400 lm, Ra 90  
dimmbar

Downlight:  
LED 12,7 W, 2700 K/1100 lm, 3000 K/1200 lm,  
4000 K/1350 lm, Ra > 90 (typ. 92)

Uplight ch600:  
LED 30 W, 3000 K/3700 lm, Ra 90

Uplight ch900:  
LED 60 W, 3000 K/7400 lm, Ra 90  
dimmable

Gehäuse Housing



ch600

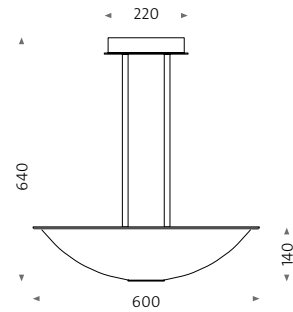

ch900

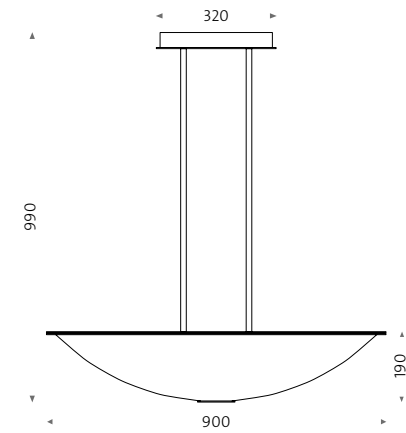

Pendelleuchten / Pendant lights



Design charlottenburg: Kardorff Ingenieure Lichtplanung Berlin; Foto: mawa

charlottenburg ch600; Wohnhaus The Charleston, Berlin  
charlottenburg ch600; residential house The Charleston, Berlin



Pendelleuchten *Pendant lights*

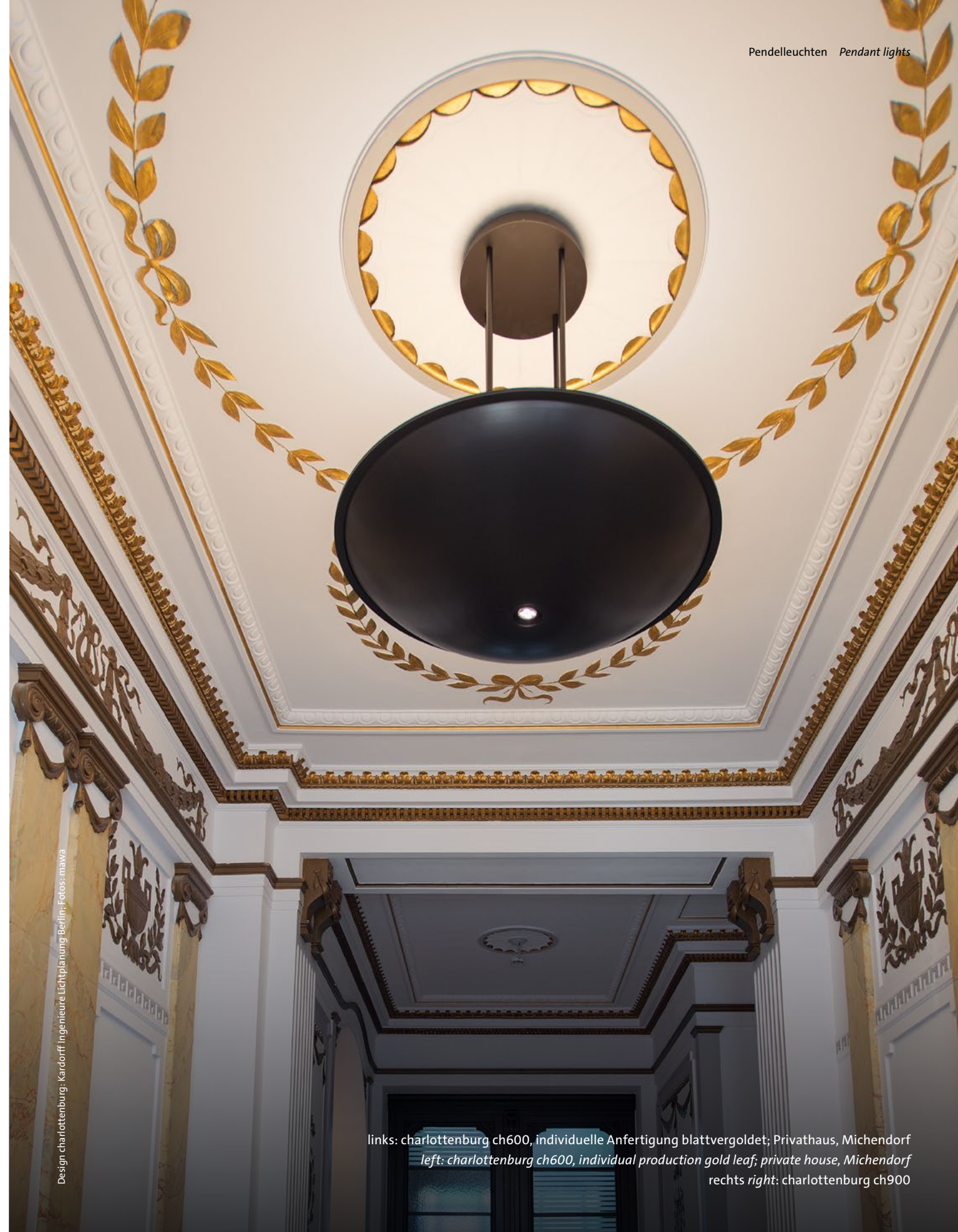

Design charlottenburg: Kardorff Ingenieure Lichtplanung Berlin, Fotos: mawa

links: charlottenburg ch600, individuelle Anfertigung blattvergoldet; Privathaus, Michendorf  
left: charlottenburg ch600, individual production gold leaf; private house, Michendorf  
rechts right: charlottenburg ch900



# humboldt uni 1

Design: Martin Wallroth

## hu1

Fassung: 3 × E27, max. 27 W, exklusive Leuchtmittel  
Gesamtpendellänge inkl. Leuchte: 0,81 m  
optionale Pendelstangenverlängerung  
Socket: 3 × E27, max. 27 W, lamps not included  
Pendant length incl. light: 0.81 m  
pendulum rod extension available

Glasvarianten  
Glass versions



Pendel mit Baldachin und Mönchskappe  
Pendant with canopy and monk's cap

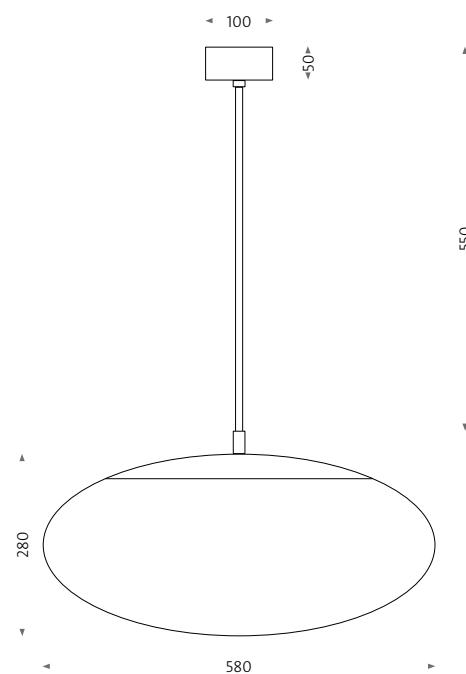

# Außenleuchten *Outdoor lights*

Die außenraumtauglichen Maßanfertigungen von mawa sind zeitlos und langlebig. Sie zeugen allesamt von kluger Gestaltung und erstklassiger Verarbeitung. Die technisch hochwertigen Leuchten mit IP-Schutz finden sich an Fassaden, auf Terrassen oder als Wegbeleuchtung in Parks oder Gärten.

*The custom-made products from mawa suitable for outdoor use are timeless and durable. They all testify to clever design and superior quality workmanship. The technically high-quality luminaires with IP protection can be found on facades, on terraces or as path lighting in parks or gardens.*

Design: Höhne Architekten, Marco Schölzel, mawa

sm1

LED: 65 W, 3000 K / 5500 lm, Ra 90  
(technische Konfiguration und Ausführung nach Kundenwunsch)  
optional dimmbar (auf Anfrage)

LED: 65 W, 3000 K / 5500 lm, Ra 90  
(technical configuration and design according to customer requirements)  
optional dimmable (on request)

Gehäuse Housing

■ Beispiel ENV Baubronze matt Example ENV Baubronze matte



Foto: Stefan Wolf Lucks

spittelmarkt sm1; Wohnhaus Zinnowitzer Straße, Berlin  
spittelmarkt sm1; residential building Zinnowitzer Straße, Berlin

unter den linden 1/2

IP44

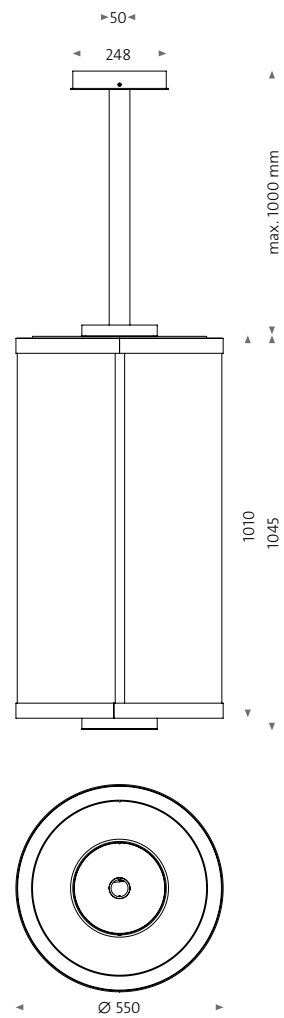
Design: Daniel Walden, mawa

ul1  
ul2

Hauptlicht-LED: ul1 16,1 W, 3000 K / 2160 lm, Ra 90; ul2 12,1 W, 3000 K / 1620 lm, Ra 90  
 Uplight-LED: ul1 25 W, 3000 K / 3160 lm, Ra 90; ul2 25 W, 3000 K / 3160 lm, Ra 90  
 Downlight-LED: ul1 25 W, 3000 K / 3160 lm, Ra 90; ul2 25 W, 3000 K / 3160 lm, Ra 90  
 Anschlussleistung (gesamt): ul1 70 W; ul2 66 W

ul1 / ul2 schaltbar

Main light LED: ul1 16,1 W, 3000 K / 2160 lm, Ra 90; ul2 12,1 W, 3000 K / 1620 lm, Ra 90

Uplight LED: ul1 25 W, 3000 K / 3160 lm, Ra 90; ul2 25 W, 3000 K / 3160 lm, Ra 90

Downlight LED: ul1 25 W, 3000 K / 3160 lm, Ra 90; ul2 25 W, 3000 K / 3160 lm, Ra 90

Connected load (total): ul1 70 W; ul2 66 W

ul1 / ul2 switchable

Gehäuse Housing



ul1 m1

Montagevariante 1 für  
Montage mit Unterkonstruktion  
Mounting variant 1 for mounting  
with underconstruction

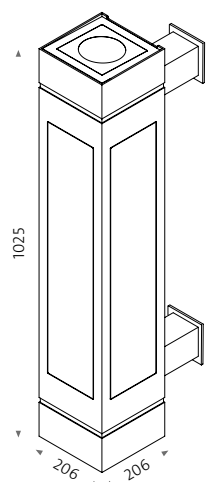

ul1 m2

Montagevariante 2 für direkte  
Wandmontage  
Mounting variant 2 for direct  
wall mounting

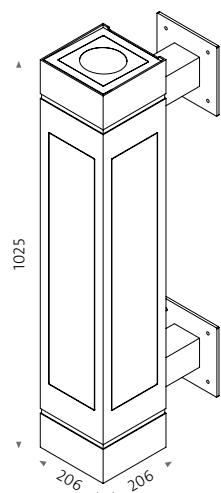

ul2 m1

Montagevariante 1 für  
Montage mit Unterkonstruktion  
Mounting variant 1 for mounting  
with underconstruction

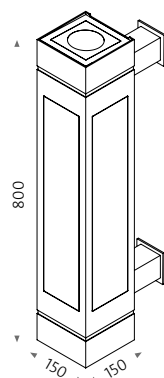

ul2 m2

Montagevariante 2 für direkte  
Wandmontage  
Mounting variant 2 for direct  
wall mounting

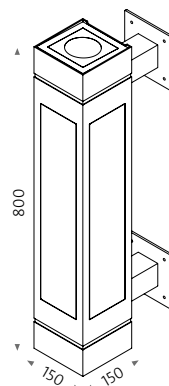

ul1



ul2



Foto: Stefan Wolf Luckis

unter den linden 1 ul1; Wohnhaus Zinnowitzer Straße, Berlin  
 unter den linden 1 ul1; residential building Zinnowitzer Straße, Berlin

# Individuell gefertigte Leuchten *Customized luminaires*

Wir orientieren uns nicht am Machbaren, sondern am Denkbaren. Mit unserer Expertise für besondere Lichtkonzepte, gelingt uns immer wieder aufs Neue, das vermeintlich Undenkbare in die Realität umzusetzen.

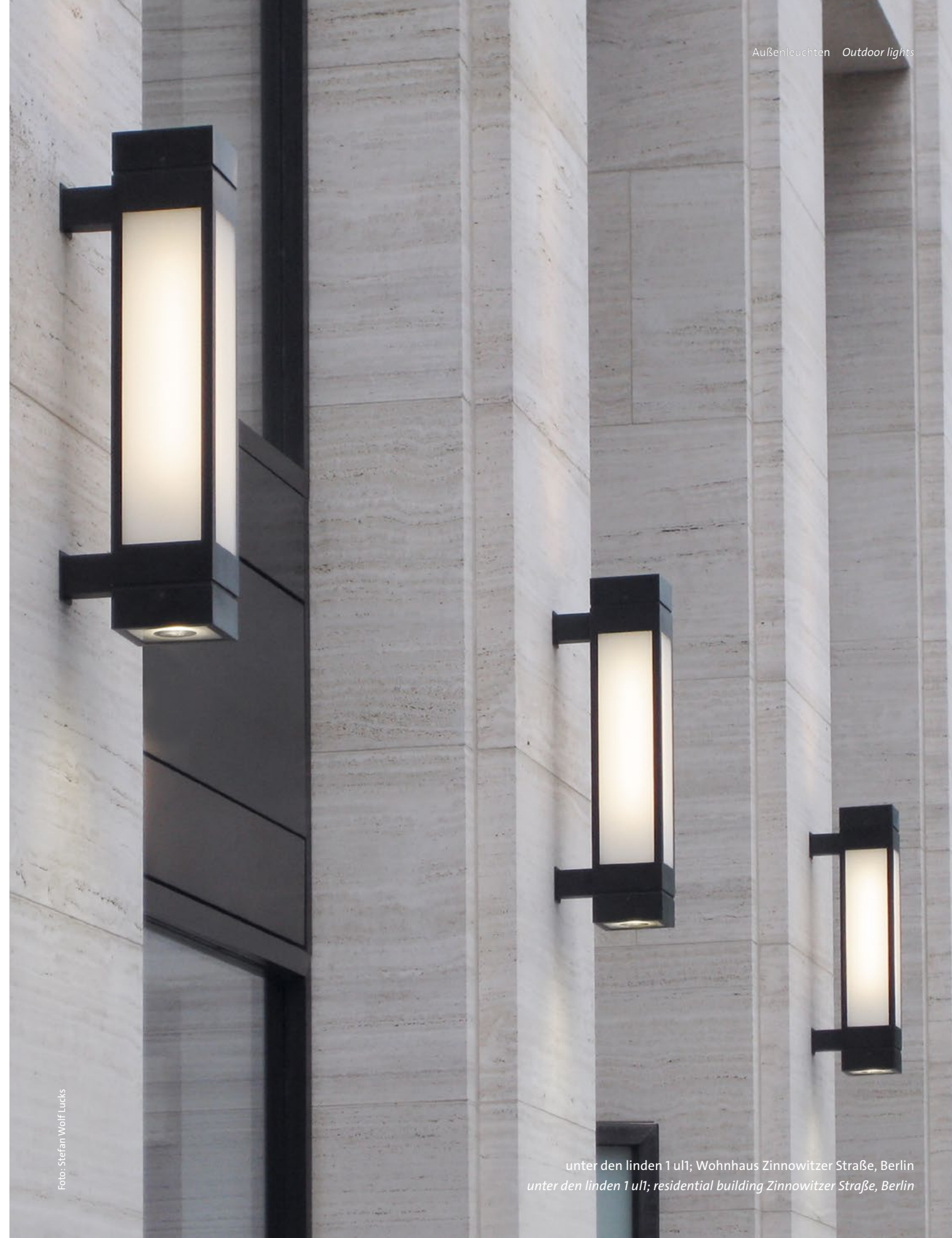
*We do not focus on what is feasible, but on what is conceivable. With our expertise in special lighting concepts, we succeed time and again in turning the supposedly unthinkable into reality.*













individuell gefertigte zylindrische Pendel-Rohrleuchte; Historisches Rathaus, Bad Oldesloe  
customized cylindrical pendant tube light; Historisches Rathaus, Bad Oldesloe

Fotos: Niemeier



Entwurf: Edgar Schlaefle; Andreas Weichshner



individuell gefertigte Stabzylinderleuchten; Büro- und Geschäftshaus Upper West, Berlin  
customized cylindrical rod lamps; Upper West office and commercial building, Berlin



individuell gefertigte Stabdeckenleuchten 1500 mm (links), Etagenanzeiger (rechts) Ø 800 mm;  
Büro- und Geschäftshaus Upper West Berlin  
customized rod ceiling lamps 1500 mm (left), floor indicator (right) Ø 800 mm;  
Upper West office and commercial building Berlin

Entwurf: Edgar Schlaefle; Fotos: Andreas Meichsner







»Alles kommt auf die Beleuchtung an.«  
“It all comes down to lighting.”

Theodor Fontane





Impressum *Imprint*

mawa design  
Licht- und Wohnideen GmbH

Member of the **PROLED GROUP**

Verwaltung *Headquarter*  
Neu-Langerwisch 36  
14552 Michendorf  
Germany

Produktion *Production*  
Ebereschering 12–13  
14554 Seddiner See  
Germany

Gestaltung *Design*  
mawa  
Sarah Bauer Design

Druck *Print*  
KOPA, Kaunas

Technische Änderungen  
und Irrtümer vorbehalten.  
*Subject to technical  
modifications and error.*

[www.mawa-design.de](http://www.mawa-design.de)

WEEE-Reg.-Nr. DE 945 963 57

Auflage *Edition*  
03 / 2023

»Alles kommt auf die Beleuchtung an.«

Zitat Theodor Fontane

mawa®

Made in Brandenburg  
[mawa-design.de](http://mawa-design.de)